

A01.01.00.00

M/A

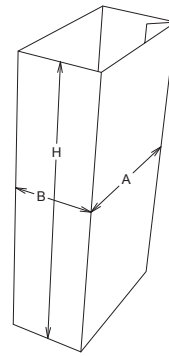
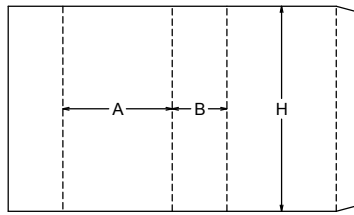

A01.15.00.03

M/A

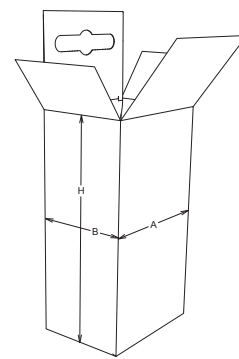
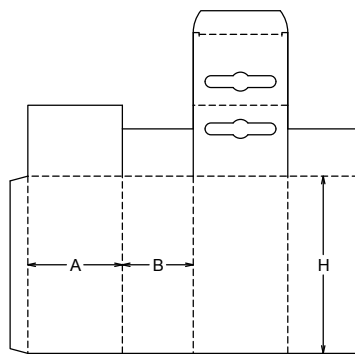

A01.55.00.01

M

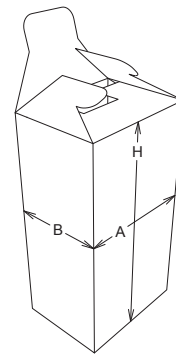
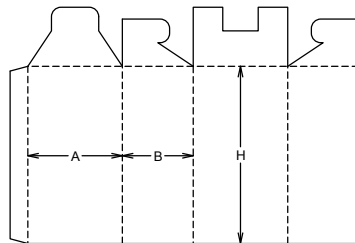

A01.60.00.00

M/A

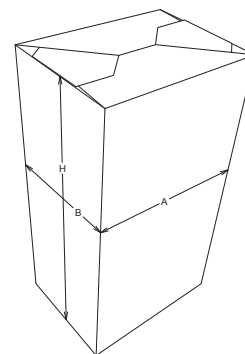
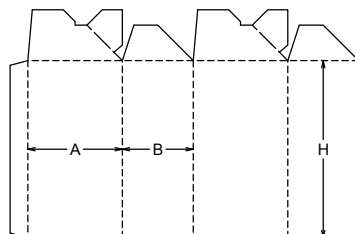

A01.70.00.00

M+A

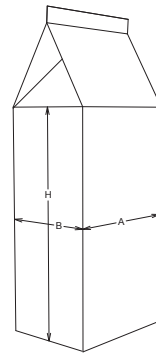
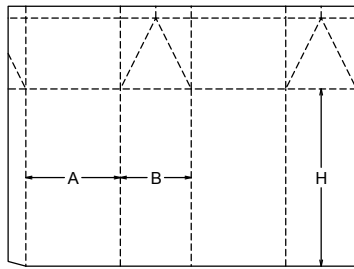

A01.75.00.03

M

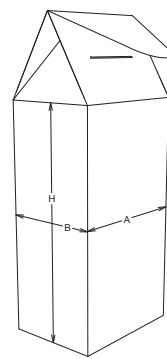
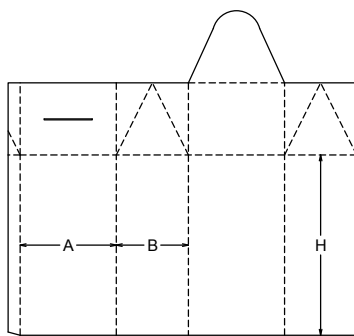

A10.01.03.00

A

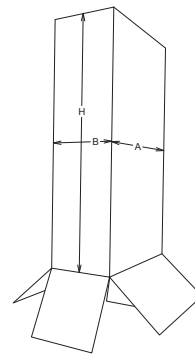
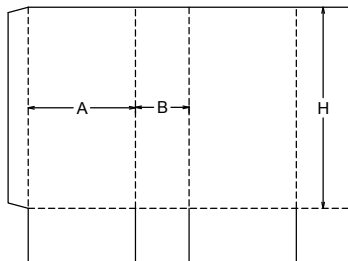

A10.10.03.03

A

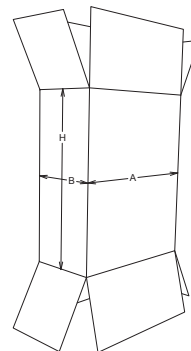
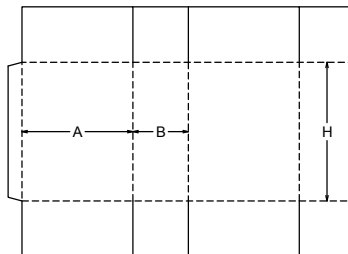

A10.11.03.03

A

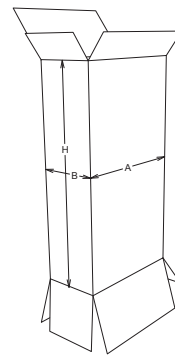
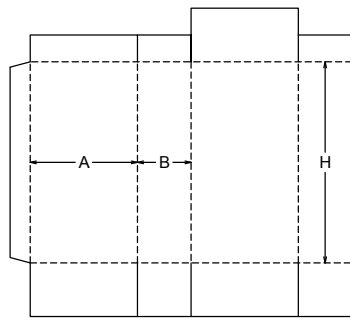

A10.15.03.03

A

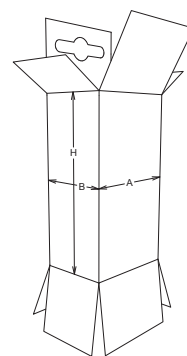
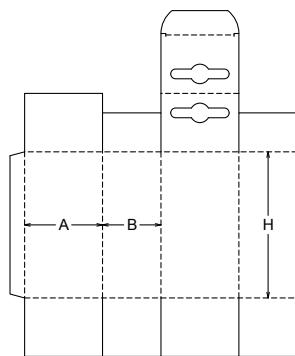

A10.20.03.03

A

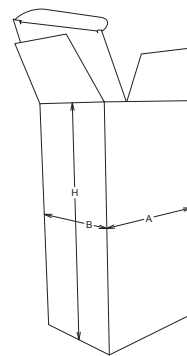
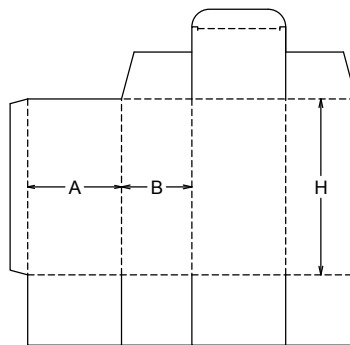

A10.21.03.03

A

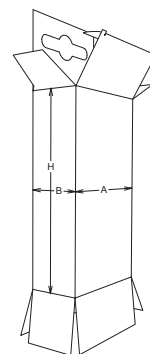
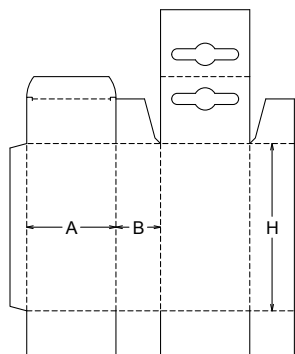

A10.75.03.03

A

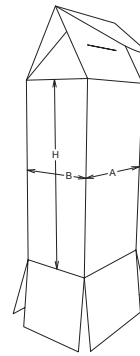
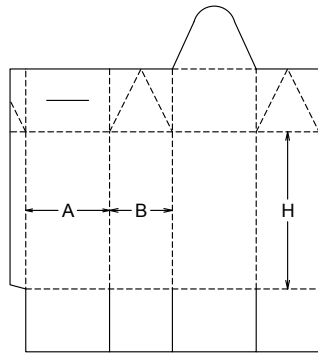

A11.10.03.03

A

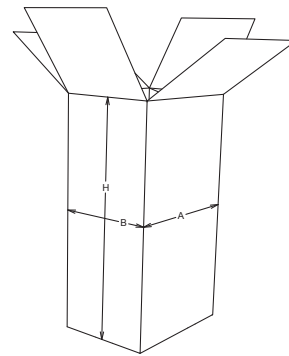
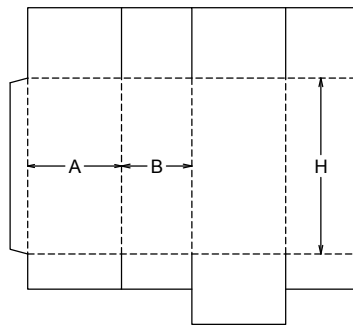

A11.11.03.01

A

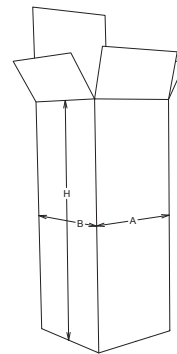
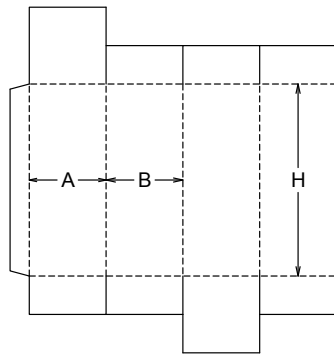

A11.15.03.03

A

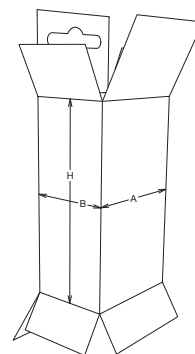
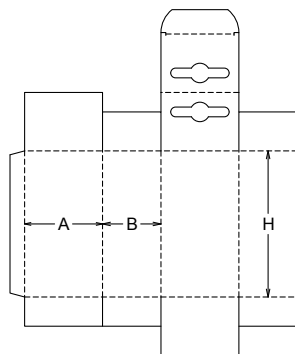

A11.20.03.03

A

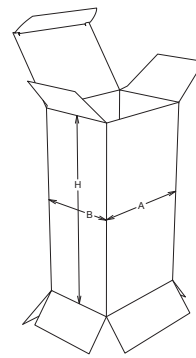
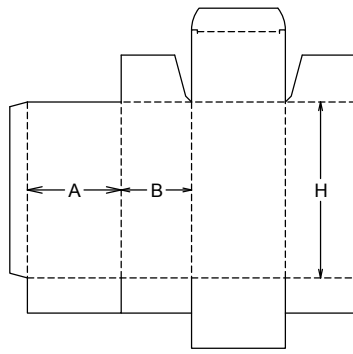

A11.21.03.03

A

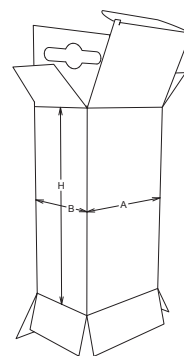
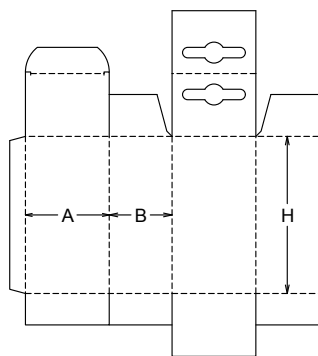

A20.01.03.00

M

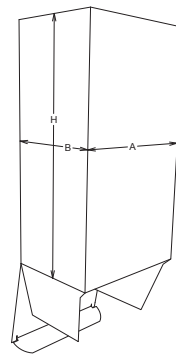
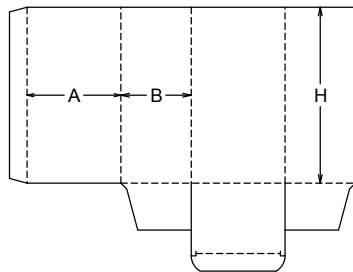

A20.10.03.03

M+A

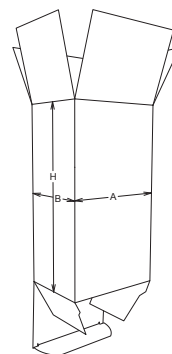
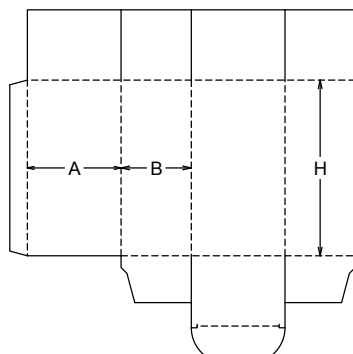

A20.11.03.01

M+A

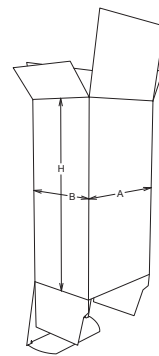
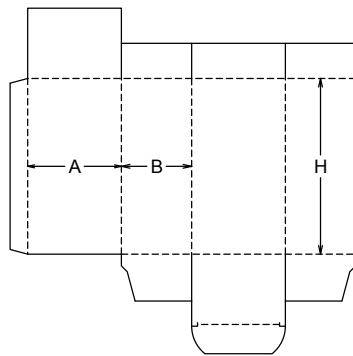

A20.15.03.03

M

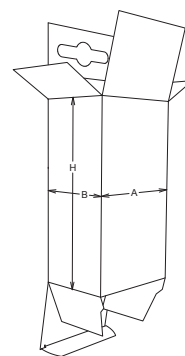
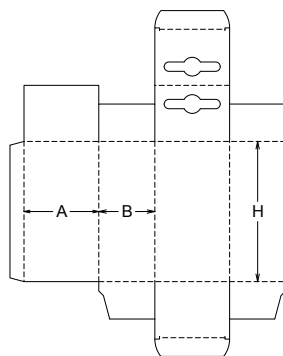

A20.20.01.01

M/A

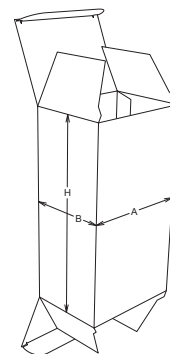
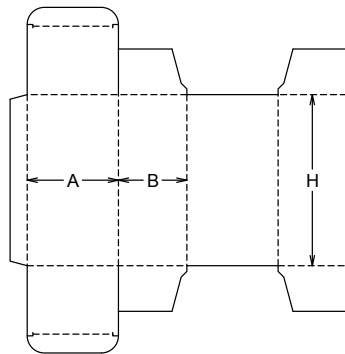

A20.20.01.03

M/A

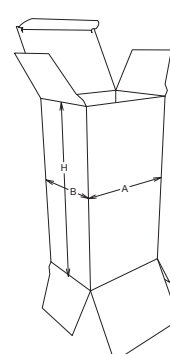
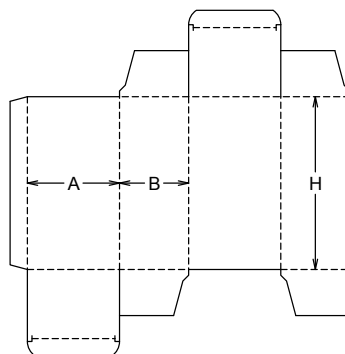

A20.20.03.01

M/A

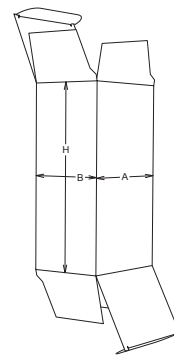
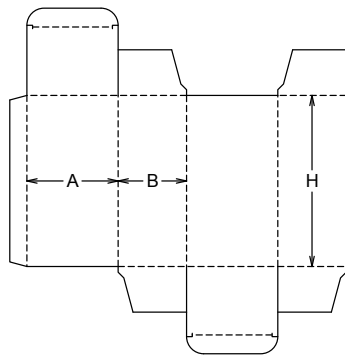

A20.20.03.03

M/A

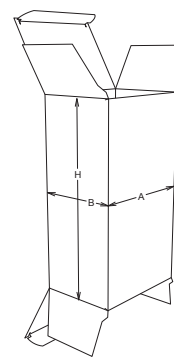
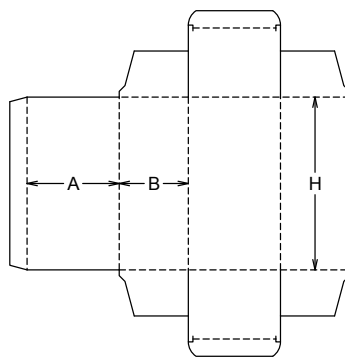

A20.21.03.03

M

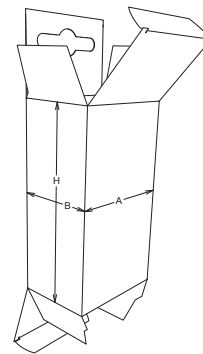
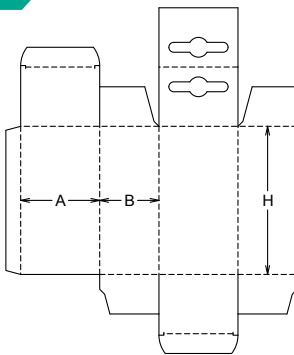

A20.50.03.01

M/A

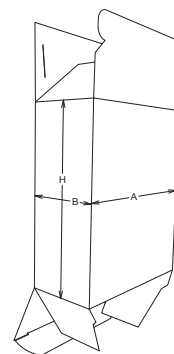
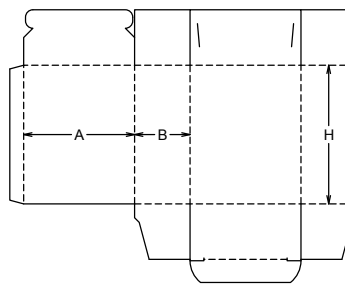

A20.82.01.00

M

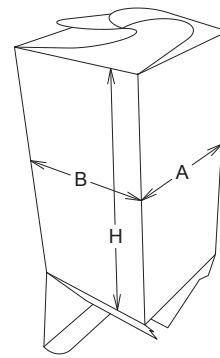
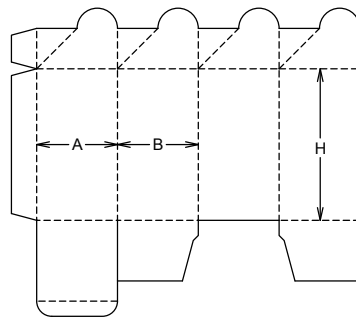

A45.20.01.03

M

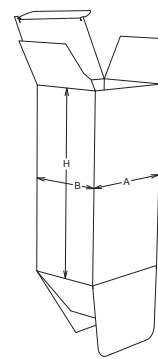
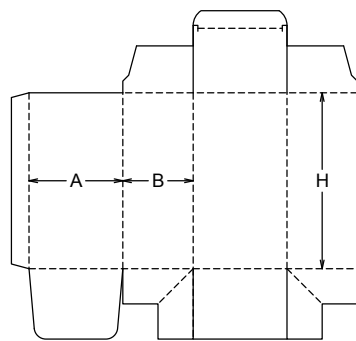

A55.01.01.00

M+A

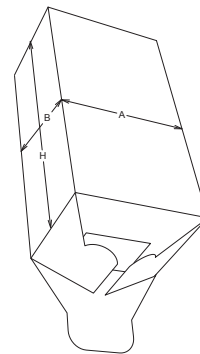
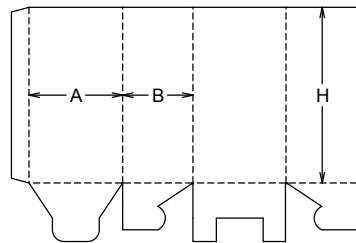

A55.10.01.03

M/A

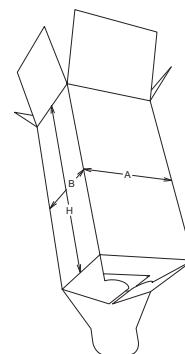
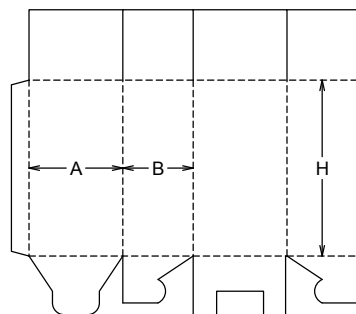

A55.11.01.03

M/A

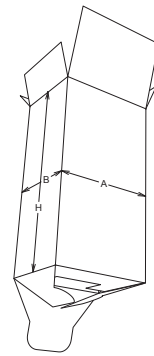
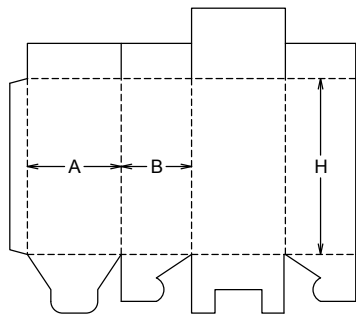

A55.20.01.03

M

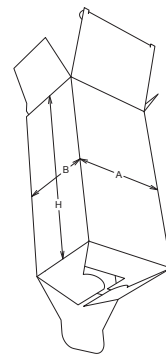
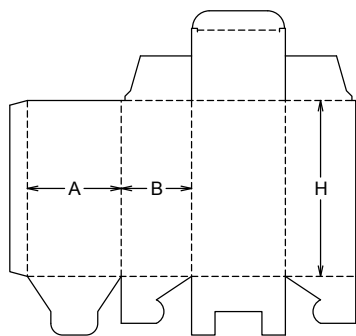

A55.21.01.03

M

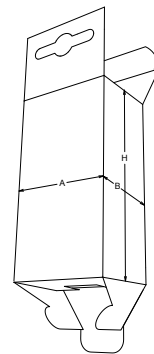
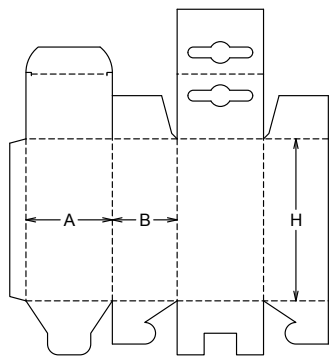

A55.75.01.03

M

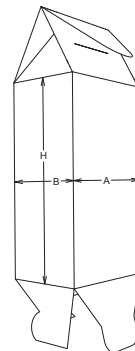
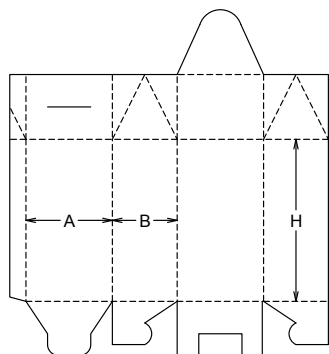

A60.01.00.00

M/A

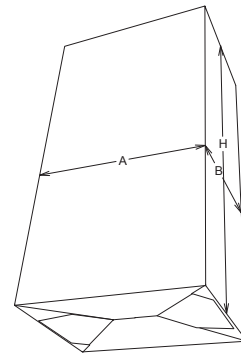
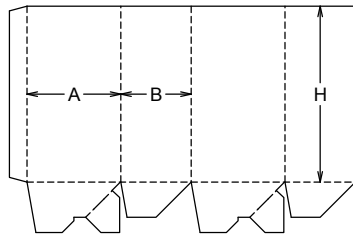

A60.10.00.03

M/A

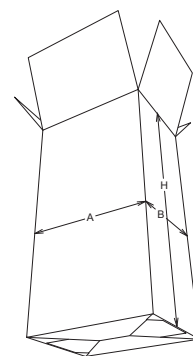
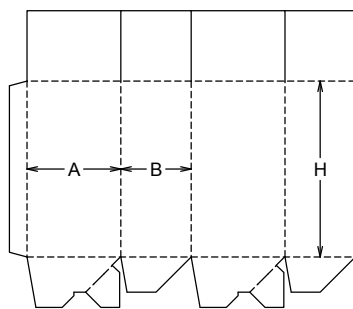

A60.11.00.03

M/A

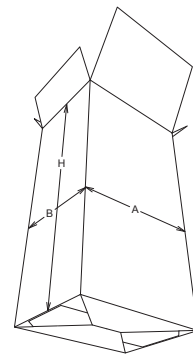
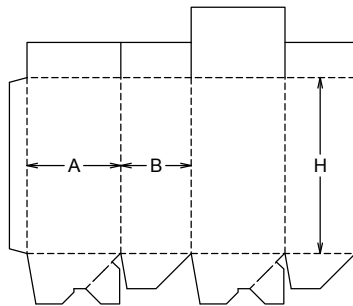

A60.15.00.03

M

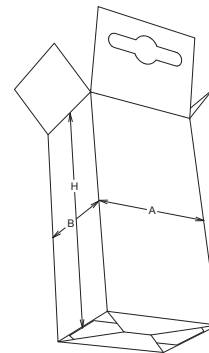
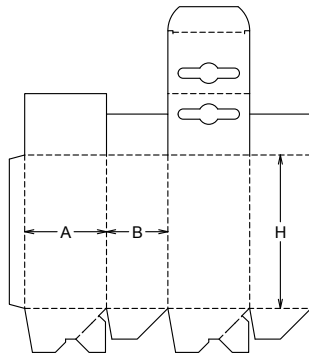

A60.20.00.03

M/A

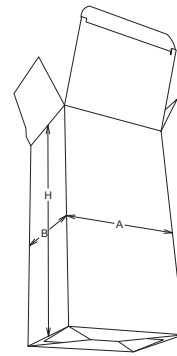
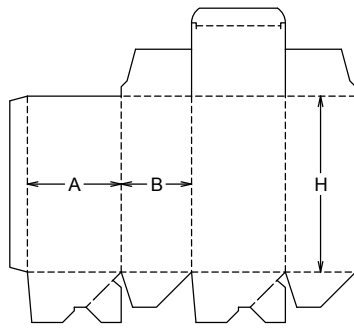

A60.21.00.03

M

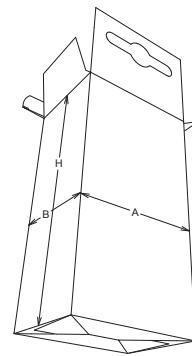
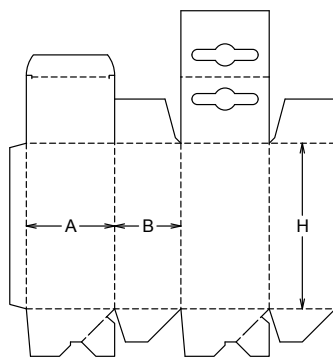

A60.45.00.01

M/A

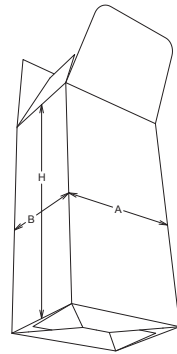
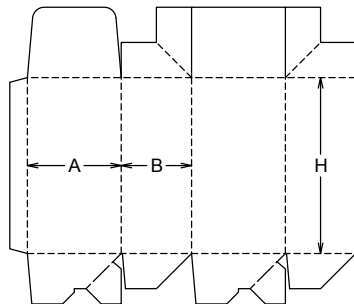

A60.75.00.03

M+A

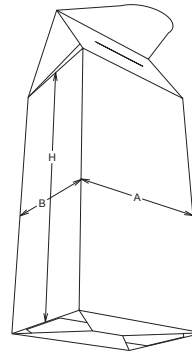
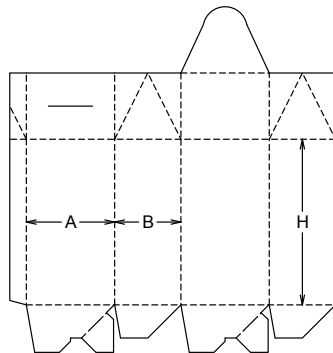

A61.01.01.00

M/A

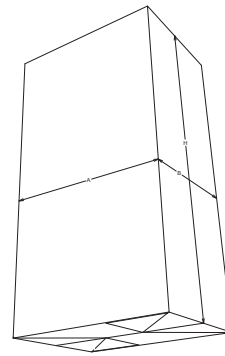
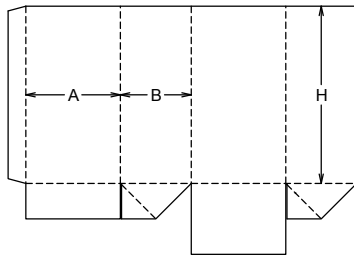

A61.10.01.03

M/A

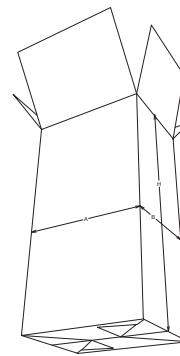
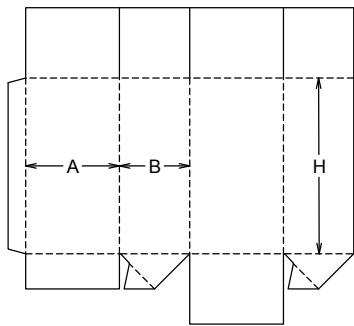

A61.11.01.03

M/A

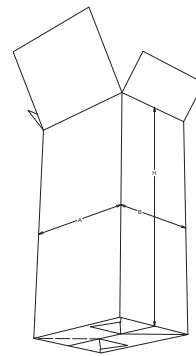
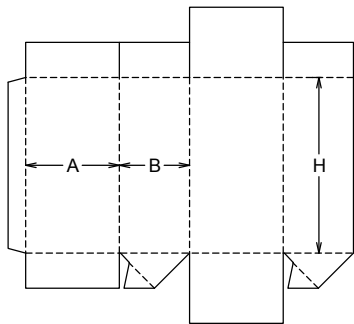

A61.15.01.03

M/A

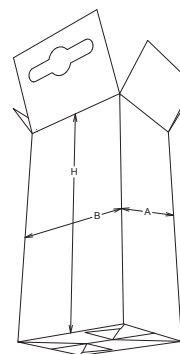
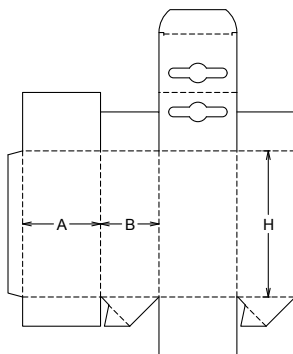

A61.20.01.03

M/A

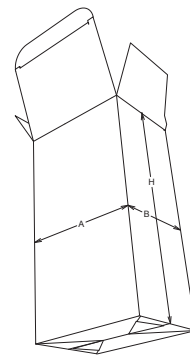
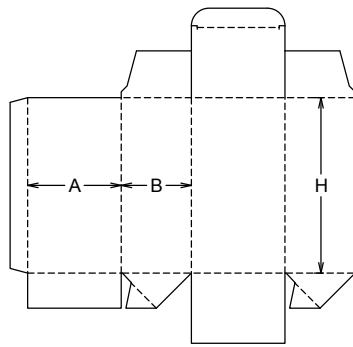

A61.21.01.03

M

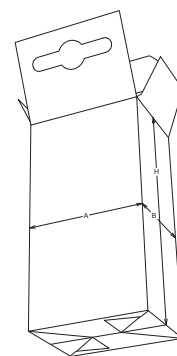
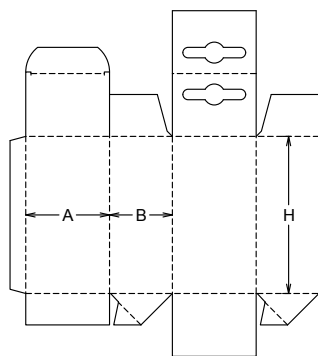

A70.70.00.00

A

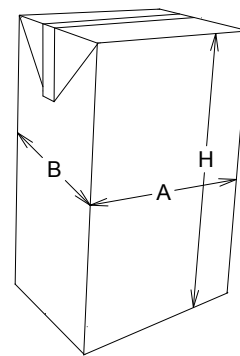
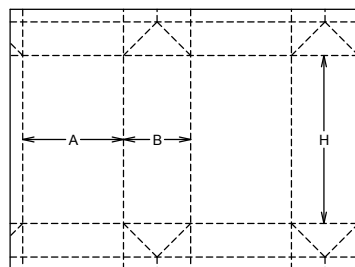

A80.20.02.02

M+A

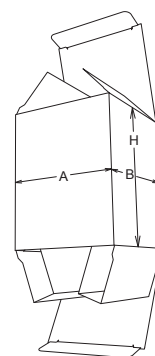
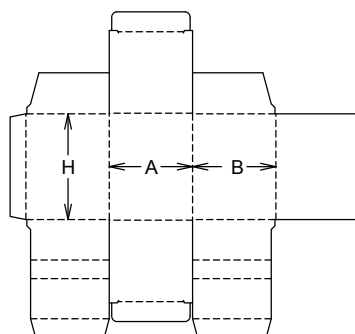

A82.82.00.00

M

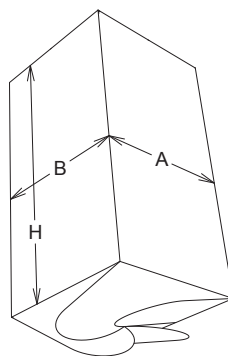
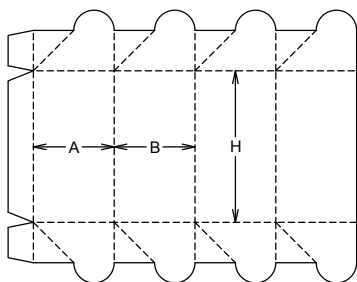

B10.01.00.00

M

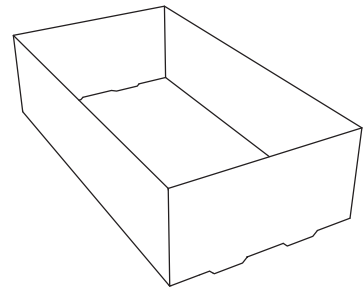
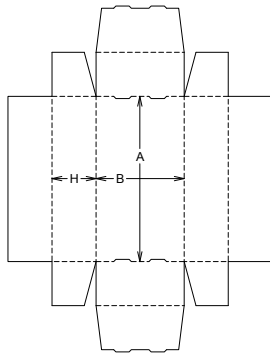

B10.02.00.00

M

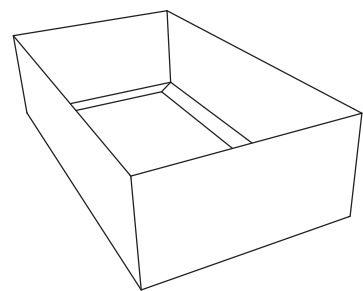
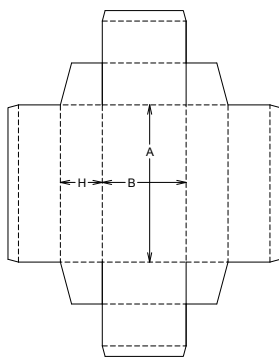

B10.04.00.00

M

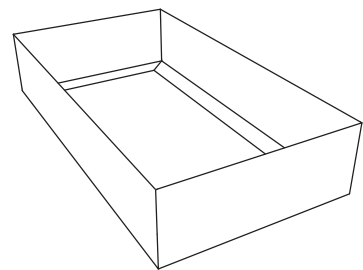
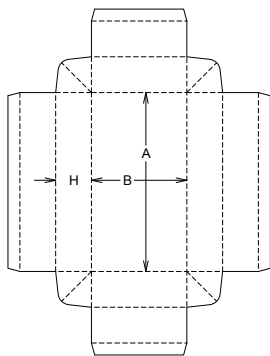

B11.02.00.00

M

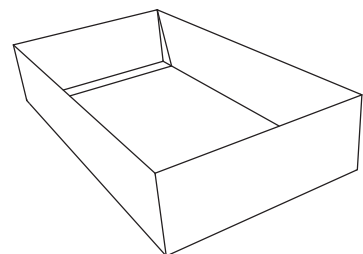
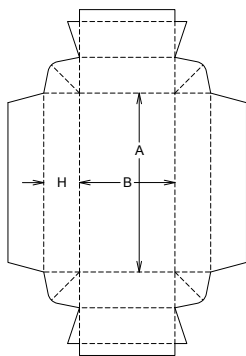

B11.04.00.00

A

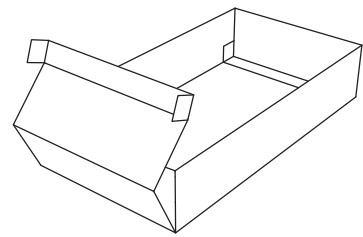
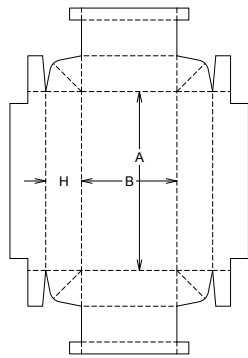

B14.02.00.00

M

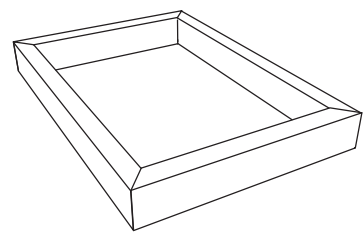
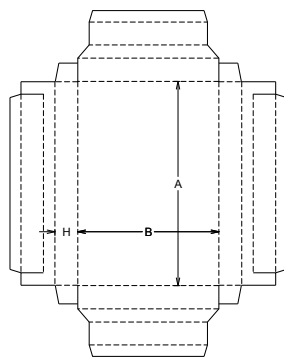

B15.06.00.00

M/A

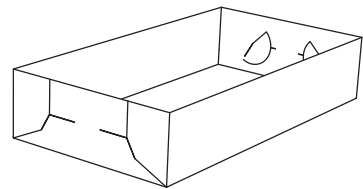
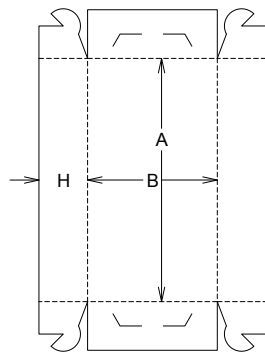

B15.06.00.53

A

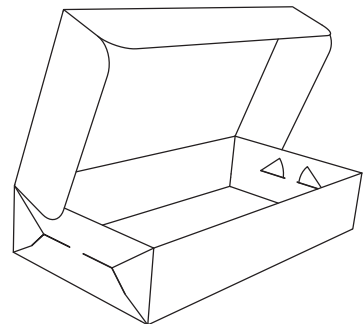
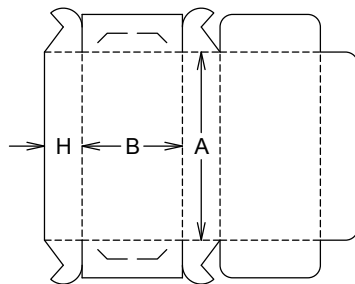

B15.06.00.60

A

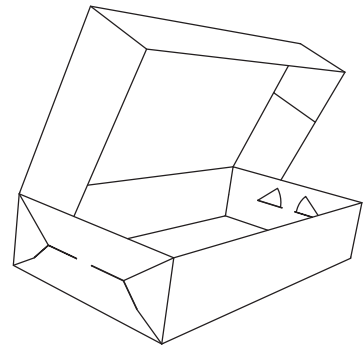
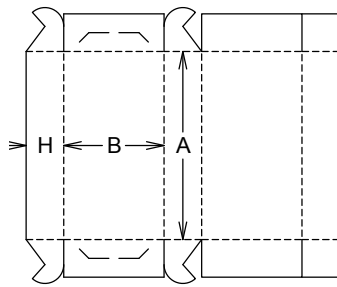

B15.07.82.00

A

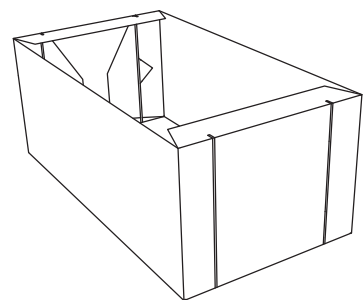
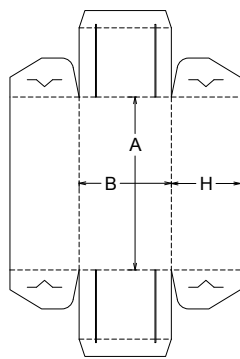

B15.11.00.00

M/A

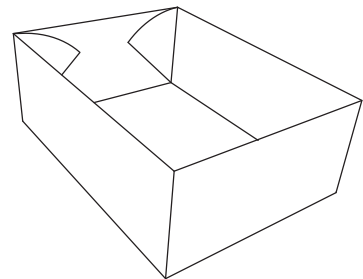
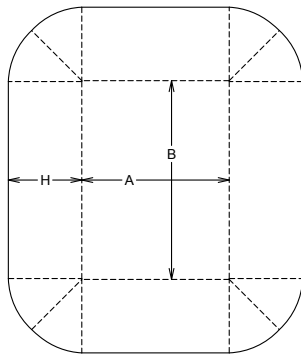

B20.01.00.00

M/A

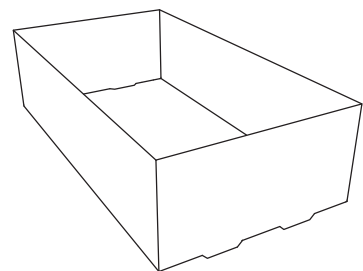
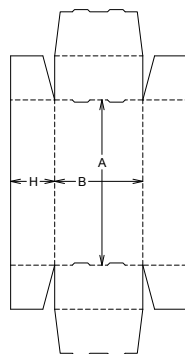

B20.01.00.50

M/A

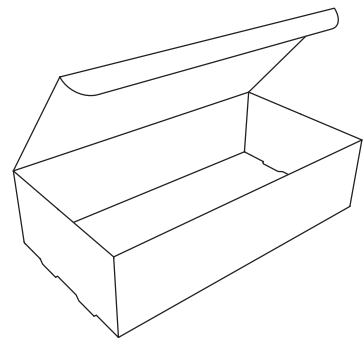
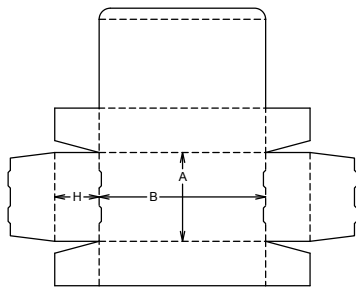

B20.04.00.00

M/A

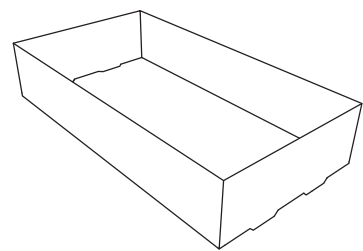
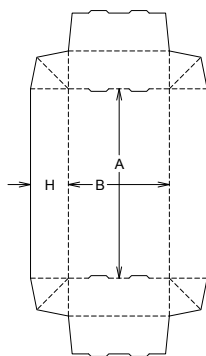

B20.05.00.00

M

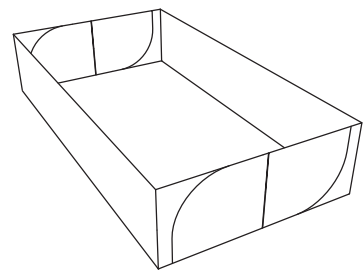
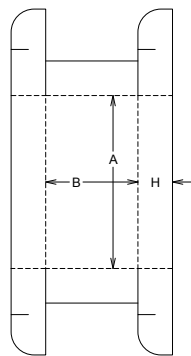

B30.02.00.00

M/A

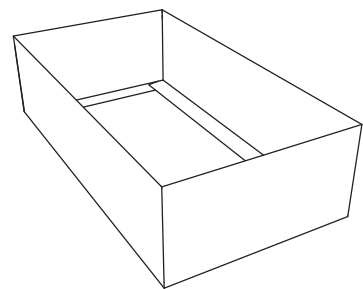
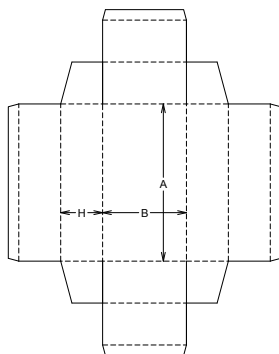

B30.04.00.00

M+A

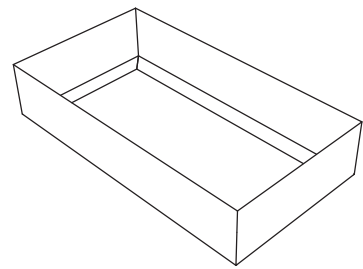
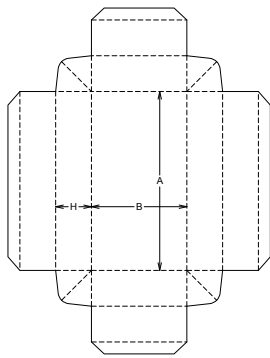

B31.02.00.00

M/A

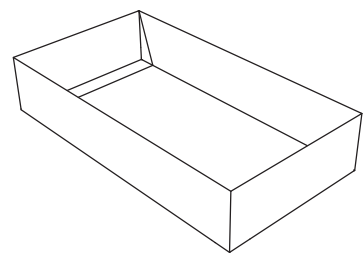
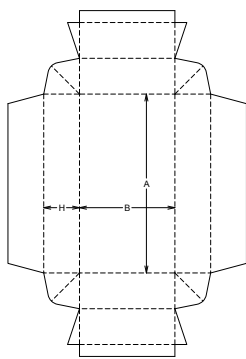

B31.04.00.00

M/A

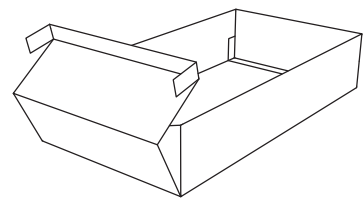
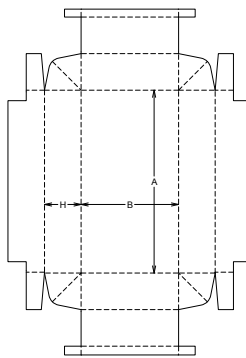

B32.02.00.00

M

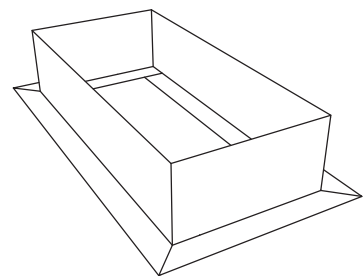
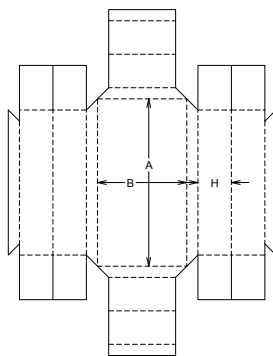

B40.20.00.00

A

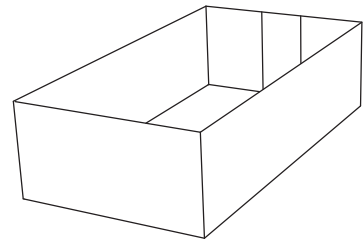
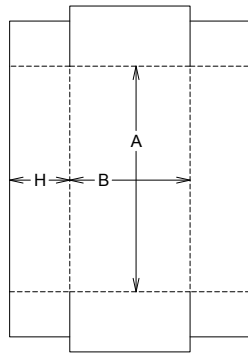

B40.20.82.50

A

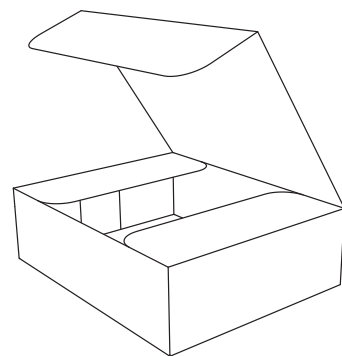
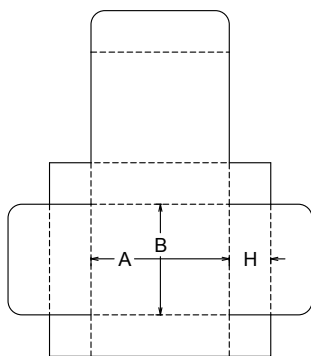

B40.20.83.53

A

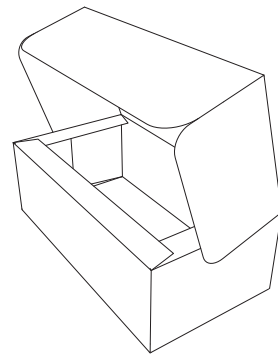
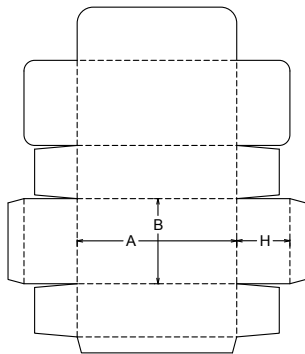

B40.20.84.00

A

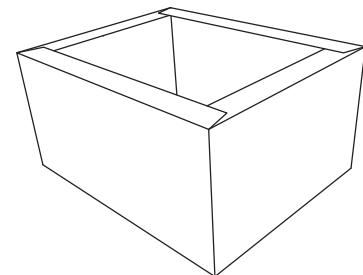
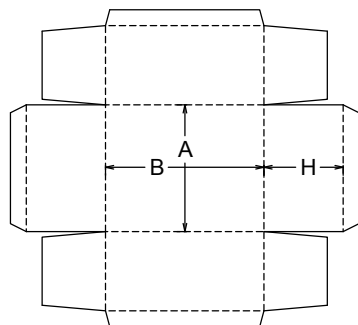

B40.21.00.00

A

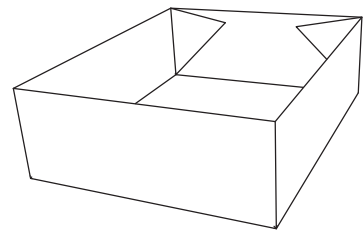
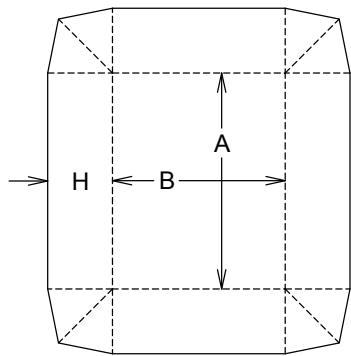

B40.22.00.00

M

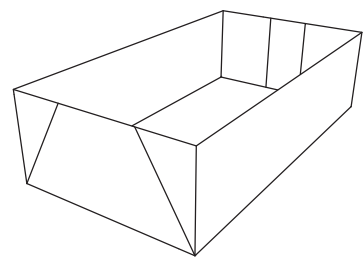
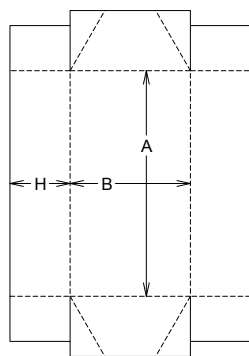

B40.22.00.61

M

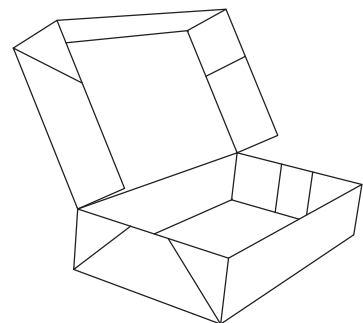
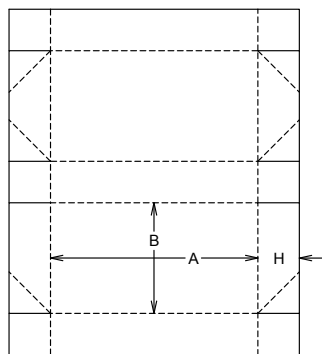

B44.20.00.00

A

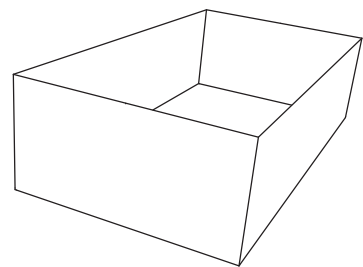
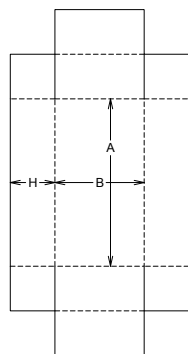

B44.20.82.00

A

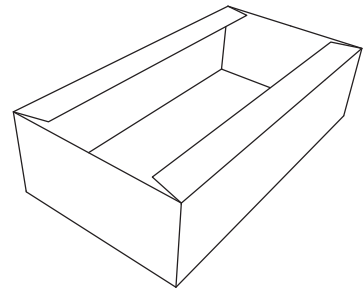
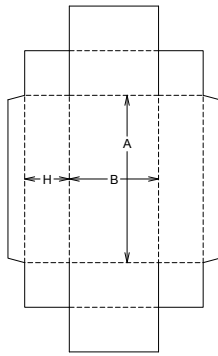

B44.23.82.00

M

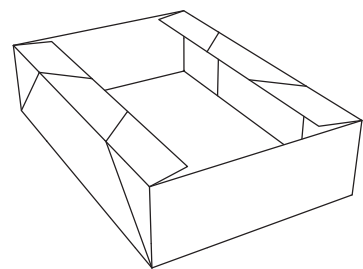
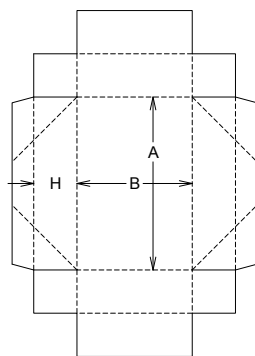

B48.02.00.00

M

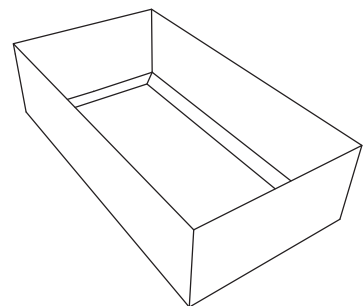
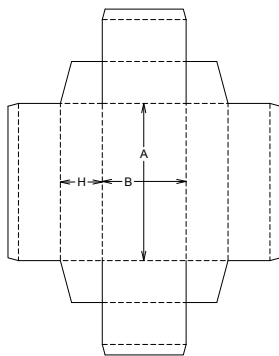

B48.20.00.00

A

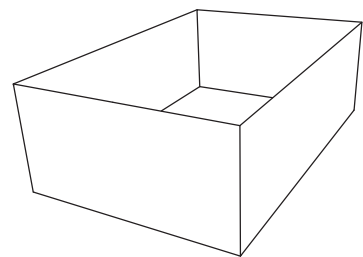
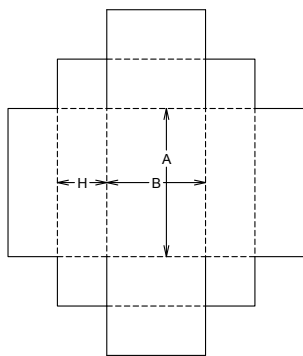

B48.21.00.00

M+A

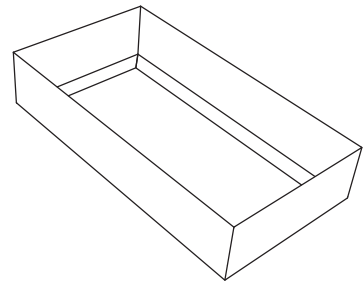
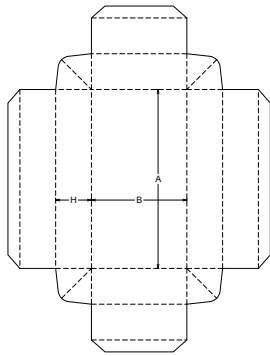

B49.20.00.00

M+A

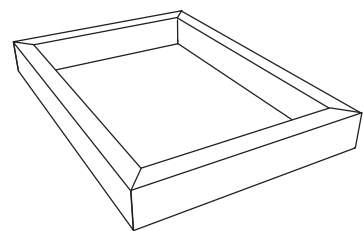
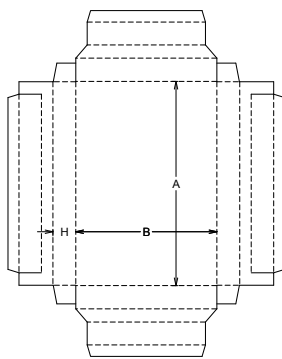

B49.21.00.51

M+A

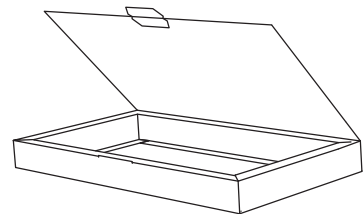
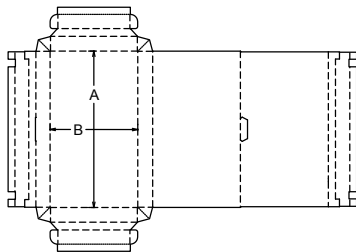

C10.10.10.10

A

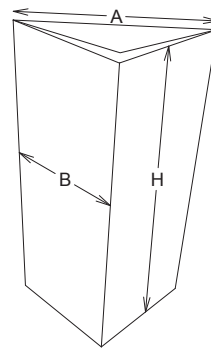
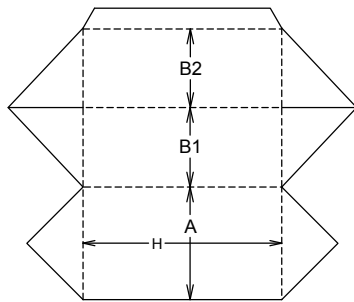

C10.10.20.20

M+A

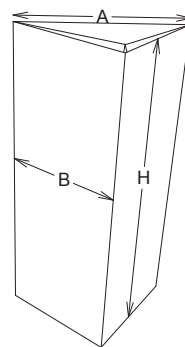
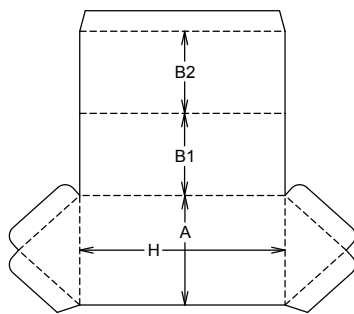

C10.40.20.20

M

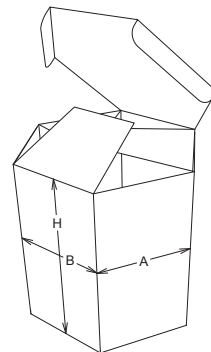
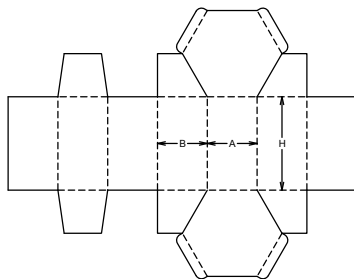

C10.40.60.20

M

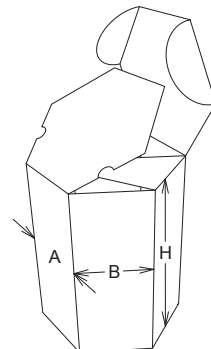
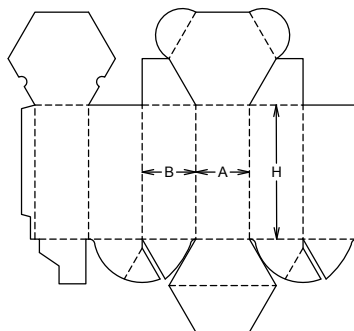

C10.40.90.90

M+A

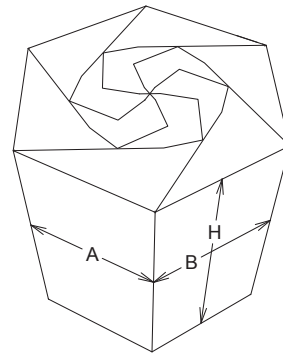
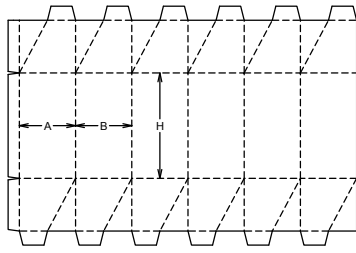

C10.50.11.11

A

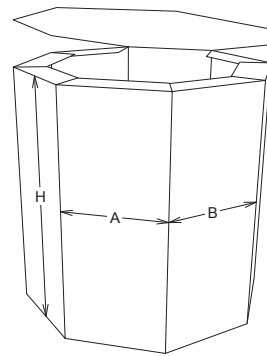
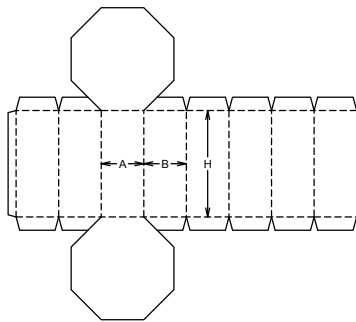

C20.20.10.10

A

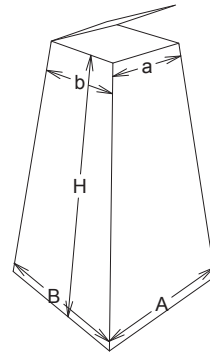
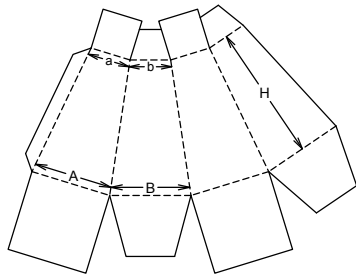

C20.20.20.20

M

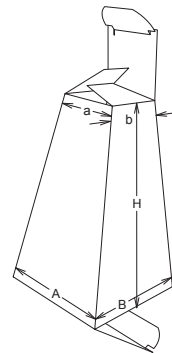
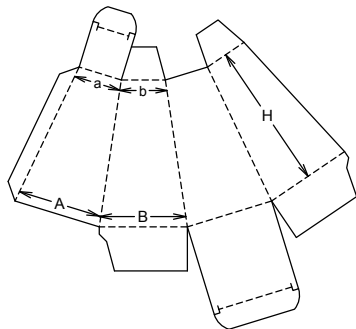

C20.20.55.20

M

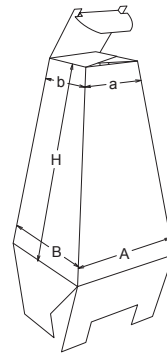
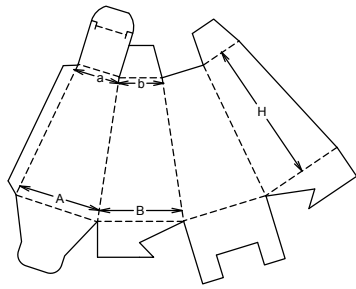

C20.20.60.20

M

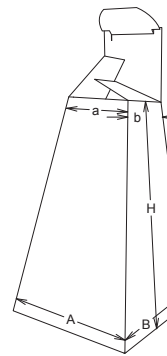
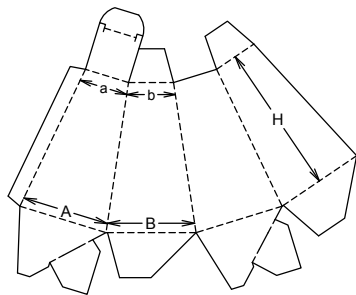

C20.30.11.11

A

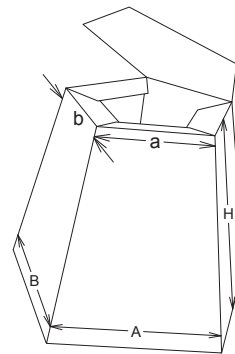
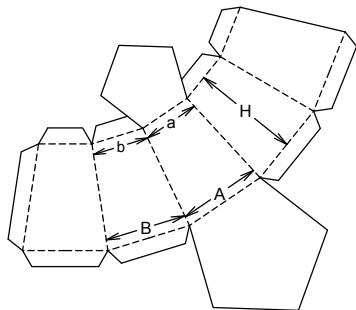

C20.40.11.11

A

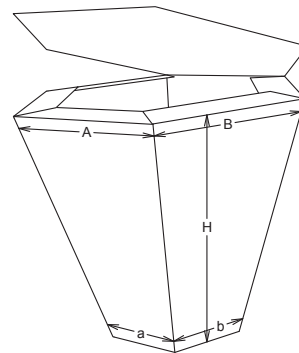
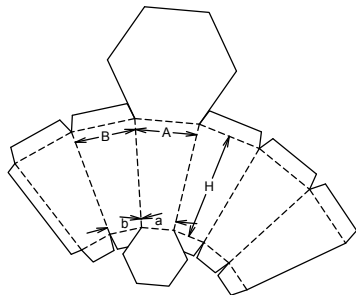

C20.50.11.11

A

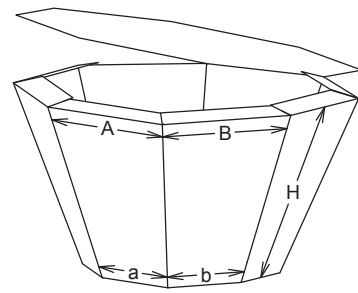
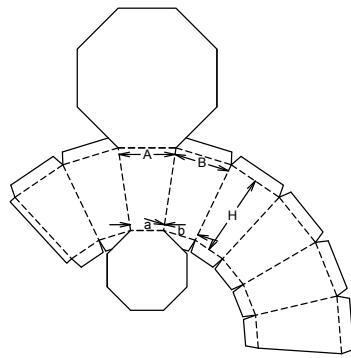

C30.10.01.11

A

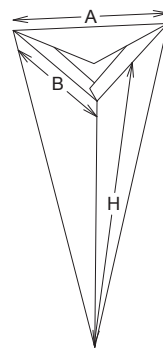
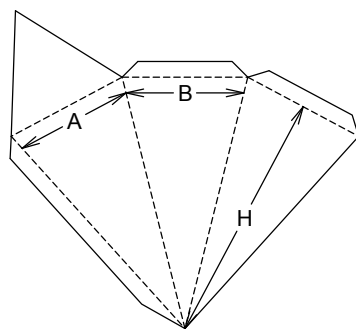

C30.20.10.01

A

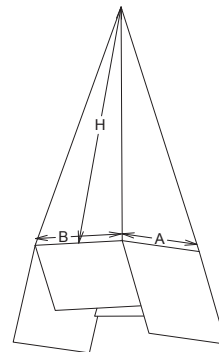
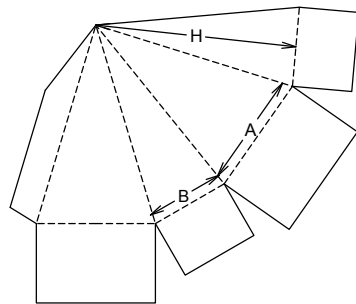

C30.20.55.01

M

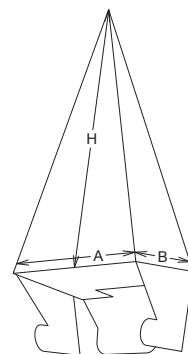
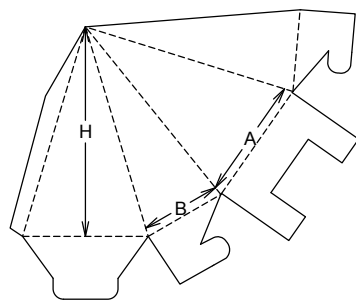

D10.41.04.00

M

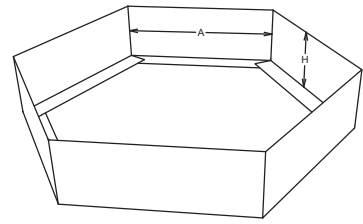
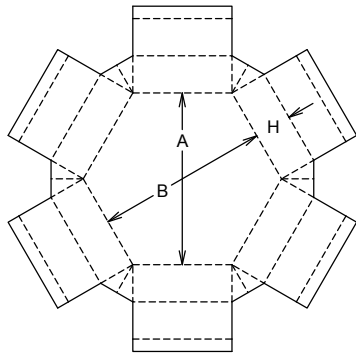

D20.20.20.00

A

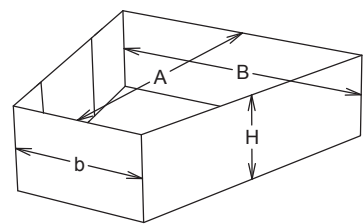
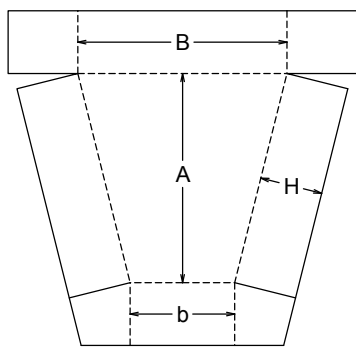

D20.20.20.50

A

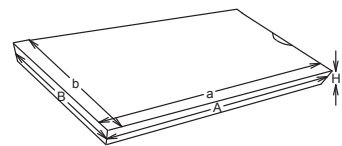
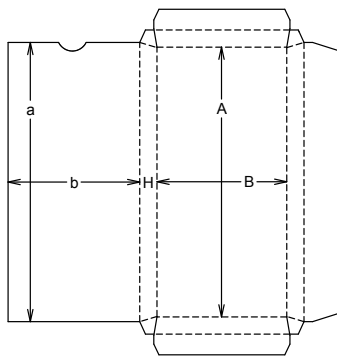

D20.20.21.00

A

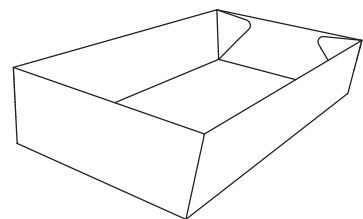
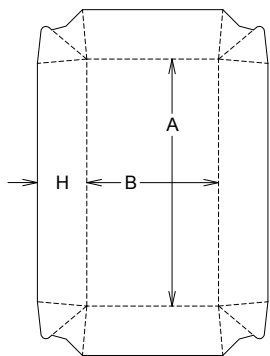

D20.20.21.62

A

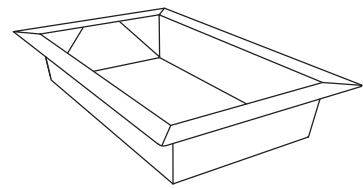
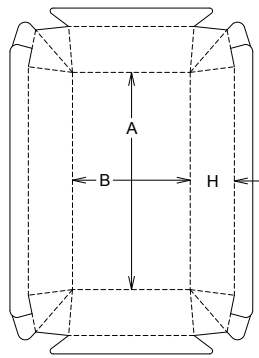

D20.21.02.00

M/A

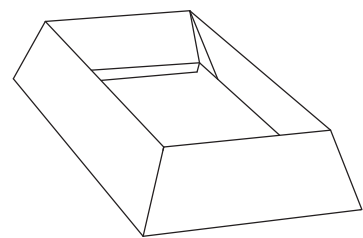
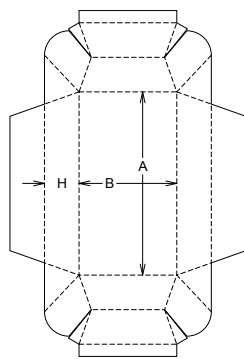

D20.50.20.00

A

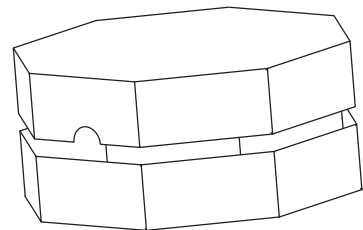
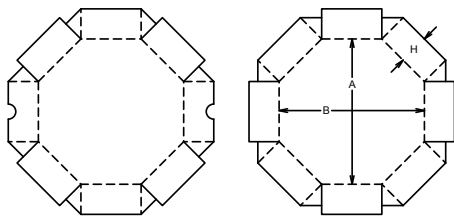

E10.11.00.00

M/A

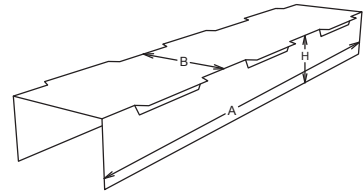
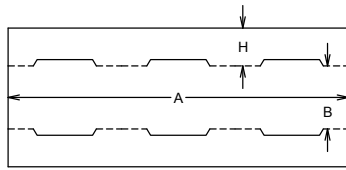

E10.20.00.00

A

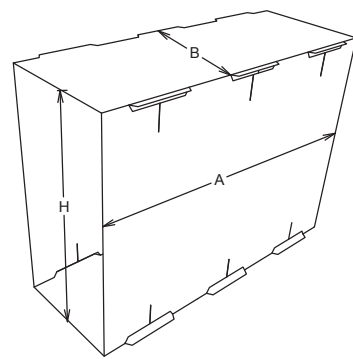
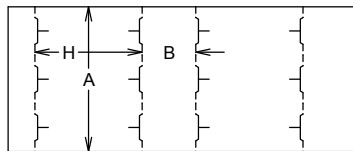

E10.21.00.00

A

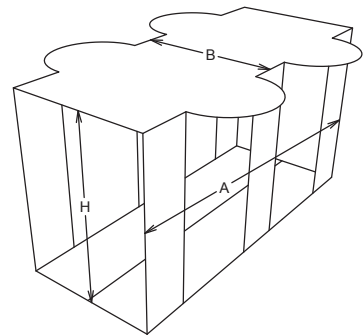
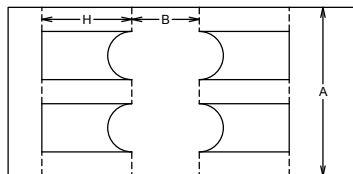

E10.30.00.00

M+A

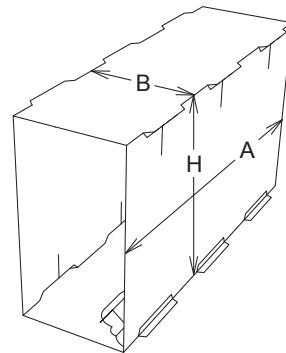
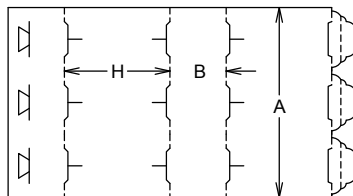

E11.20.00.00

A

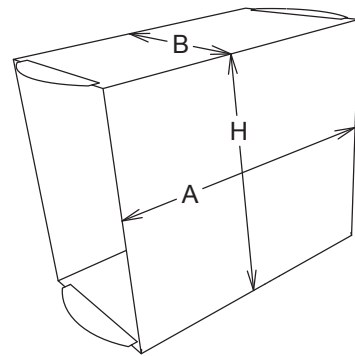
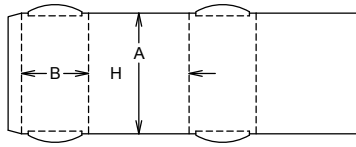

E12.20.00.00

A

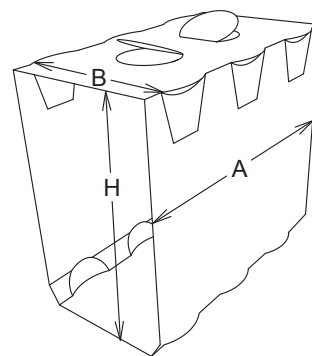
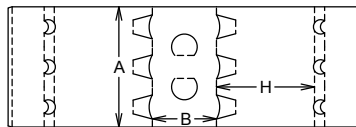

E12.30.00.00

M/A

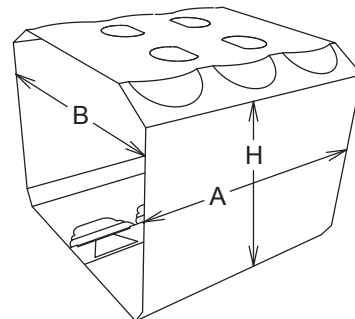
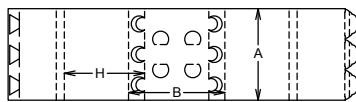

E14.11.00.00

M/A

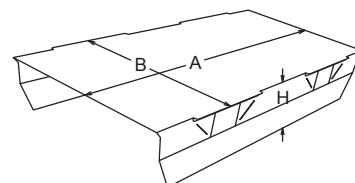
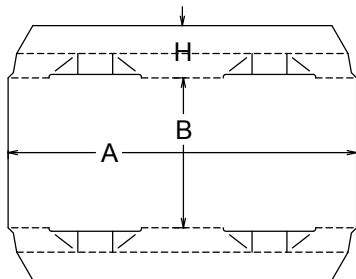

E14.20.00.00

A

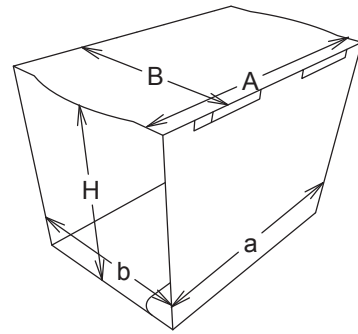
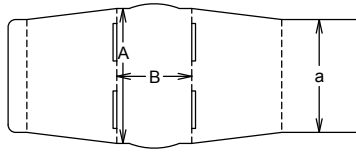

E14.21.00.00

M/A

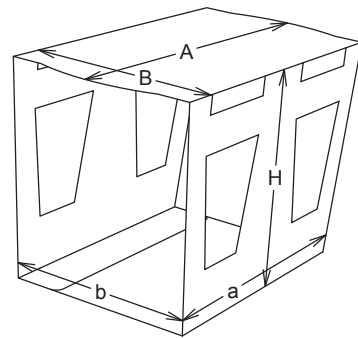
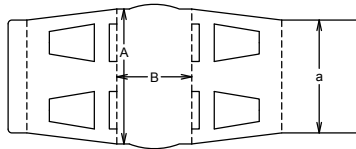

E14.30.00.00

M/A

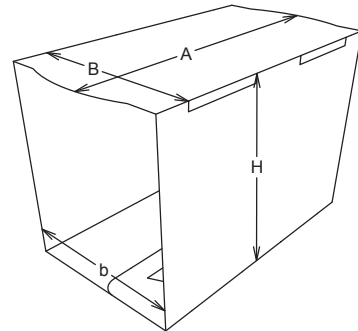
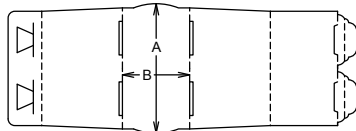

E15.20.00.00

M/A

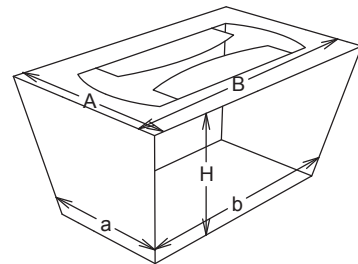
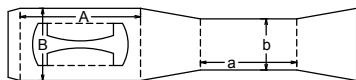

E16.20.00.00

A

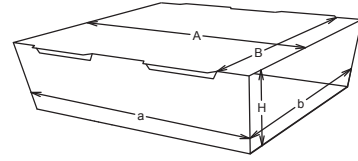
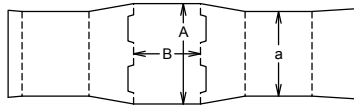

E20.20.00.00

A

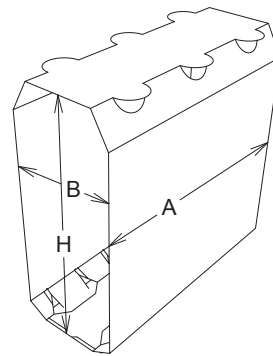
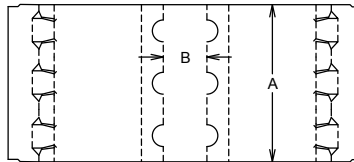

E20.21.00.00

A

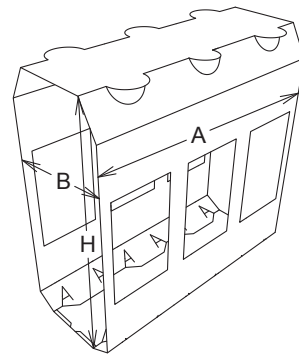
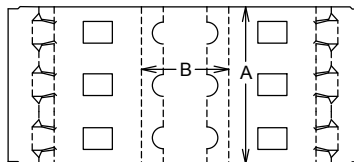

E21.10.00.00

M+A

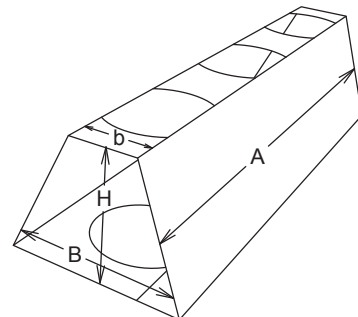
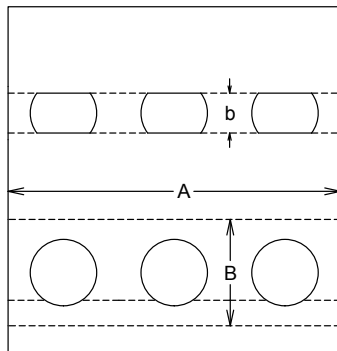

E21.20.00.00

A

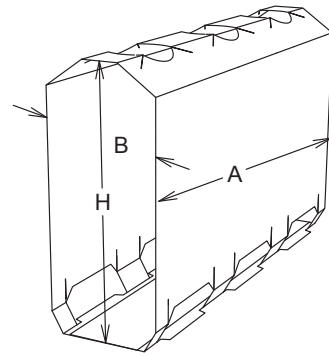
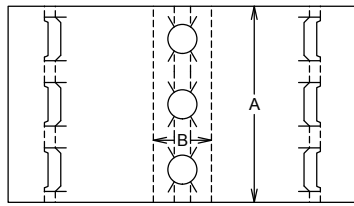

E22.10.00.00

M/A

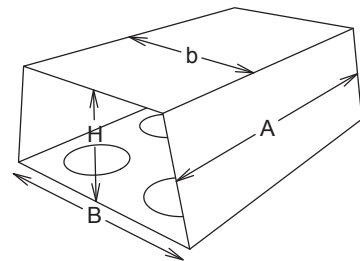
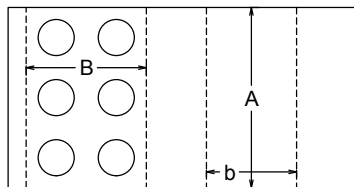

E22.20.00.00

A

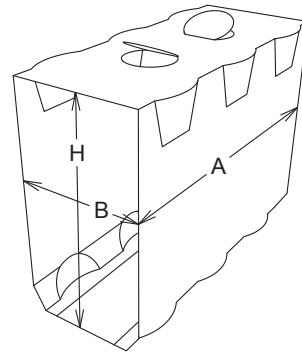
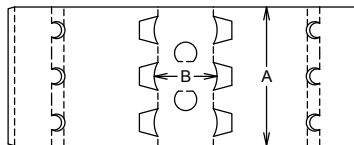

E23.20.00.00

A

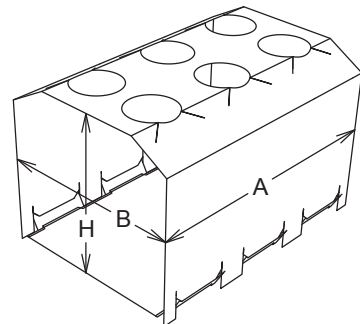
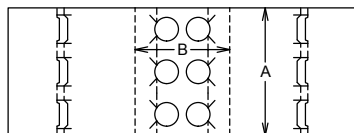

E31.20.00.00

M/A

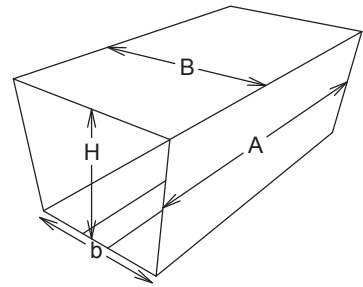
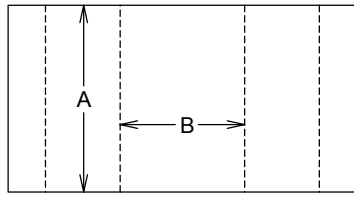

E40.82.00.00

M

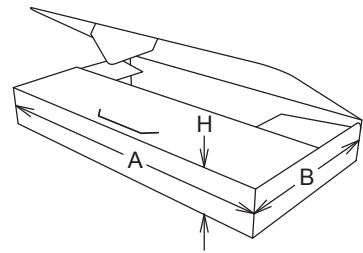
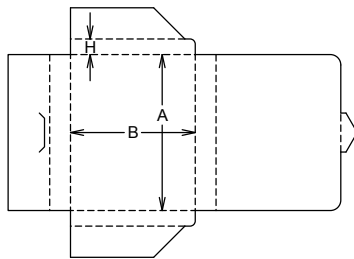

F10.11.00.00

M

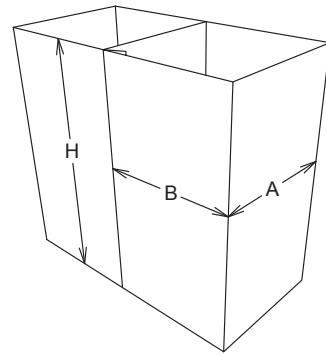
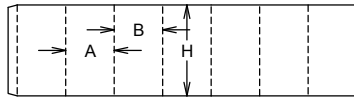

F10.12.00.00

M

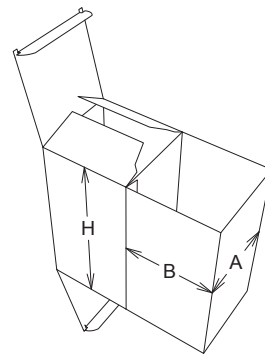
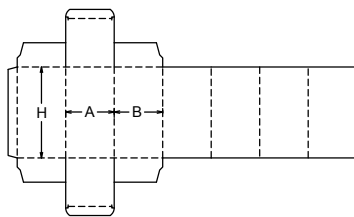

F10.13.00.00

M

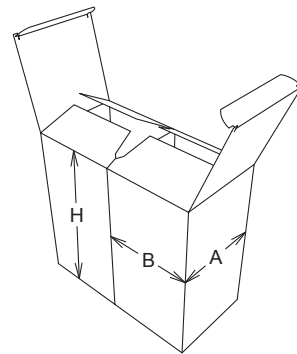
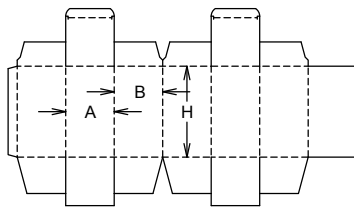

F10.41.00.00

M+A

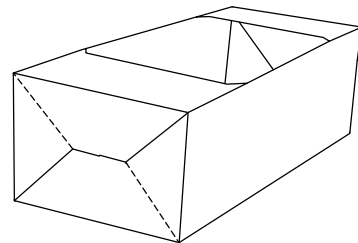
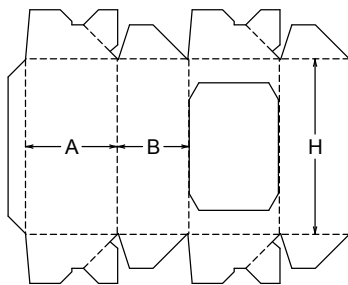

F10.51.00.00

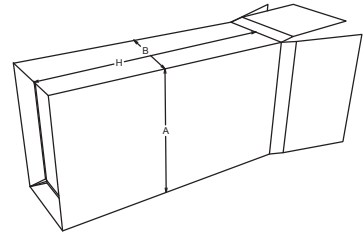
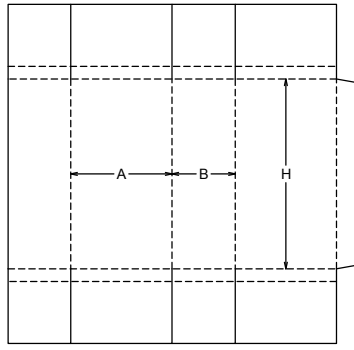

F10.81.00.00

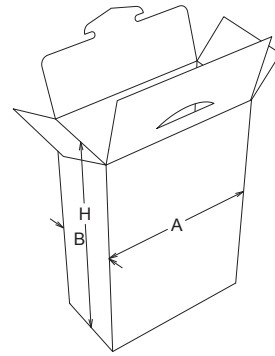
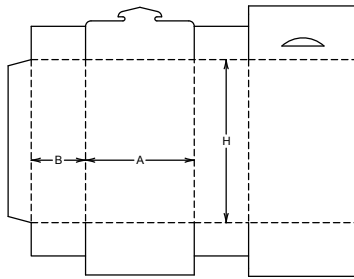

F10.82.00.00

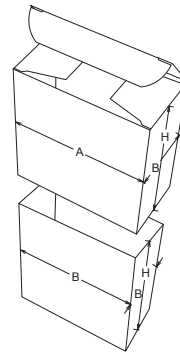
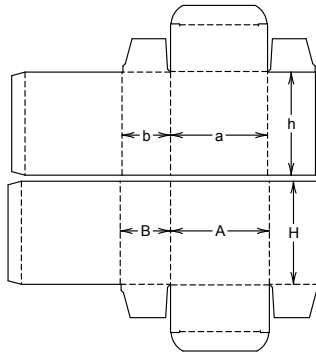

F10.83.00.00

M/A

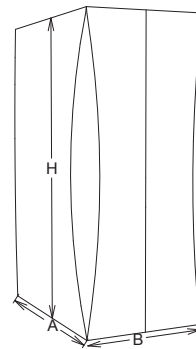
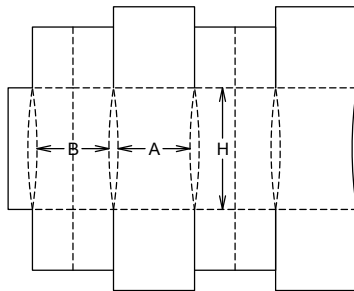

F20.01.00.00

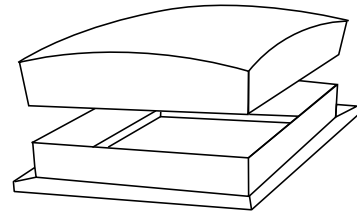
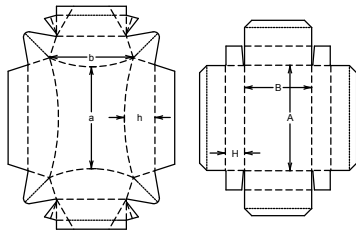

F20.33.00.00

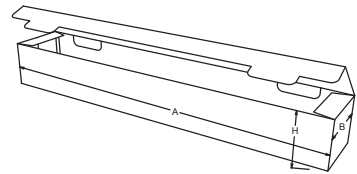
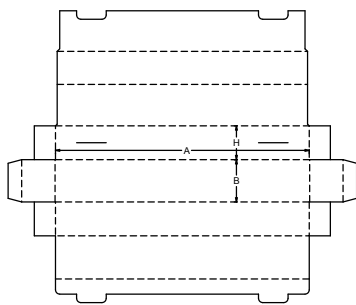

F20.36.00.00

M+A

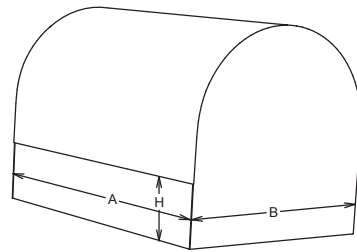
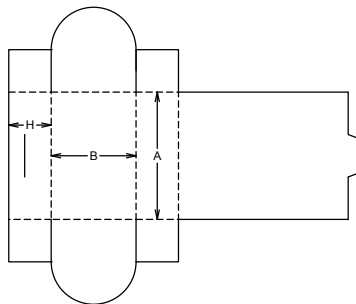

F20.37.00.00

A

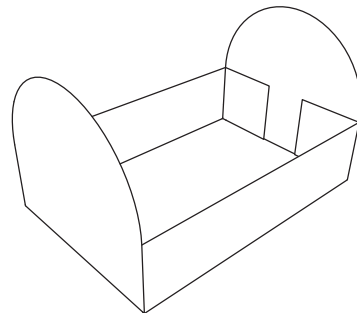
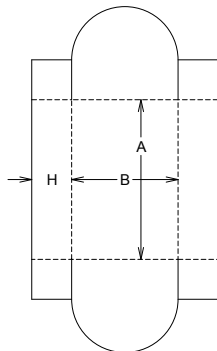

F20.41.00.00

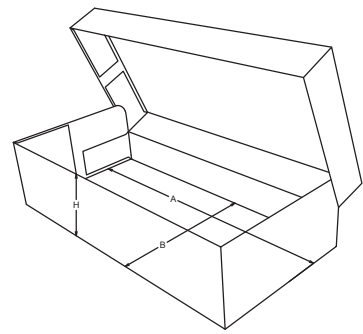
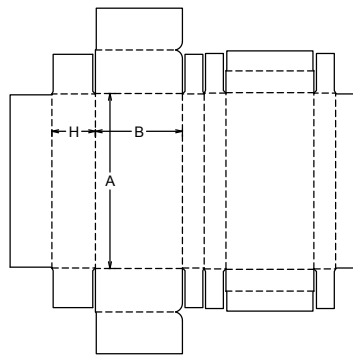

F20.42.00.00

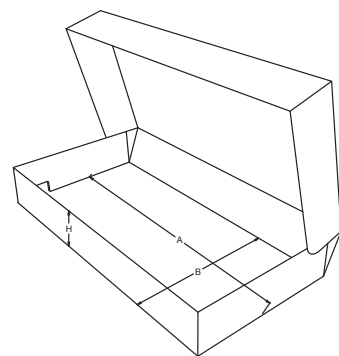
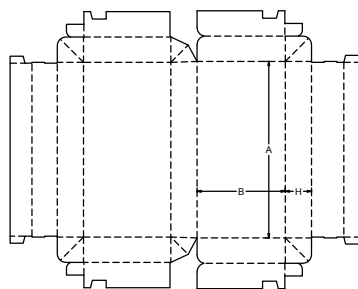

F20.51.00.00

M

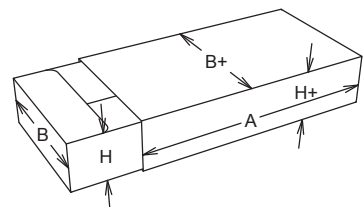
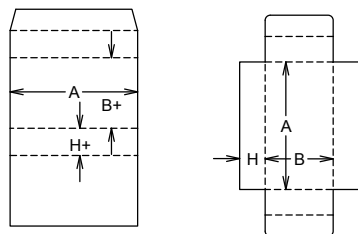

F20.52.00.00

M

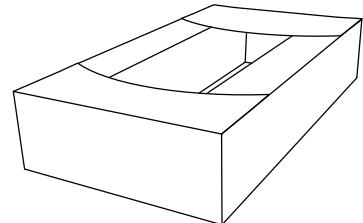
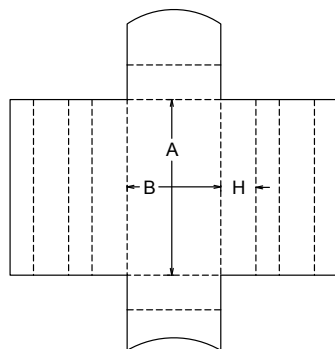

F20.53.00.00

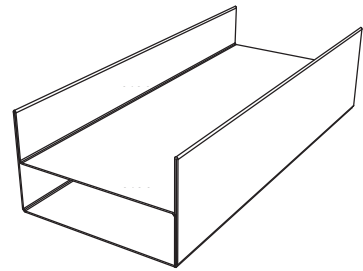
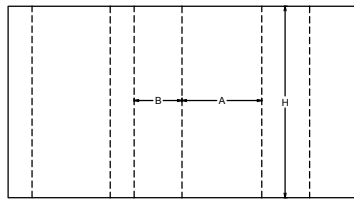

F20.60.00.00

M

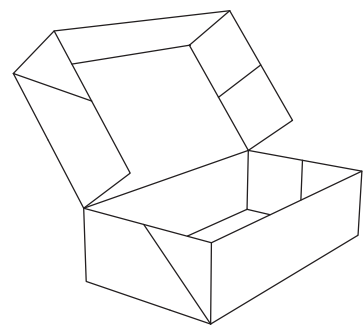
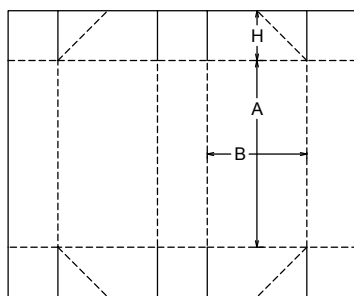

F30.22.00.00

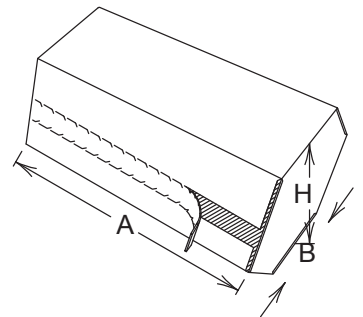
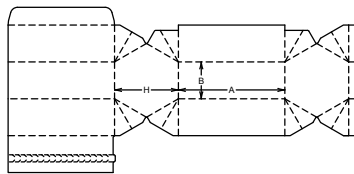

F30.52.00.00

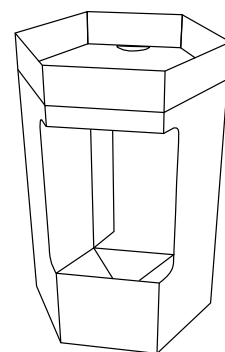
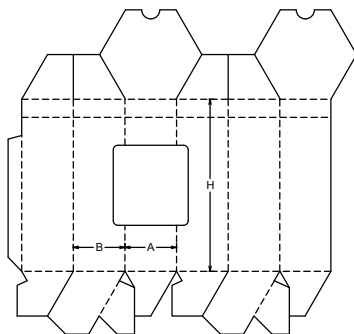

F40.01.00.00.22

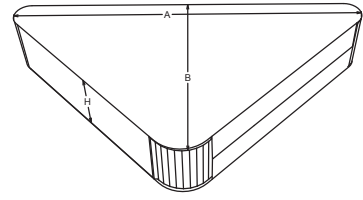
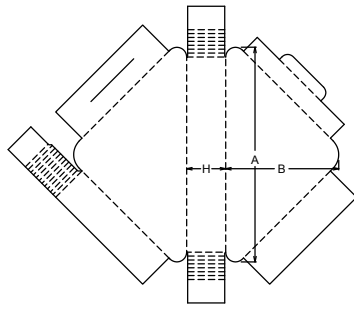

F40.02.00.00.22

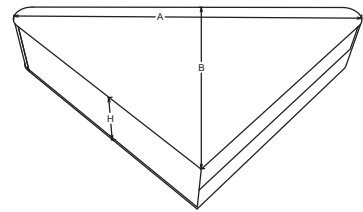
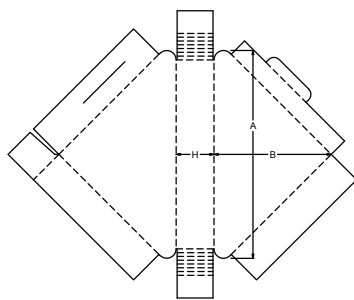

F40.03.00.00.22

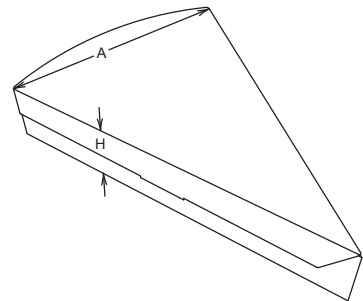
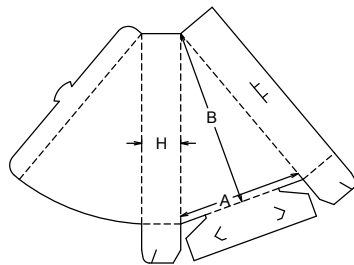

F40.04.00.00.22

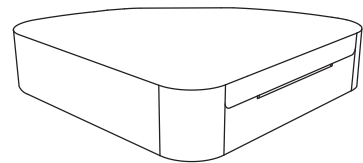
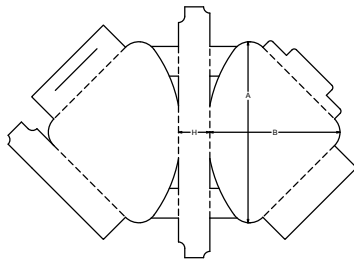

F40.05.00.00.22

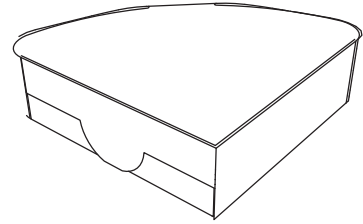
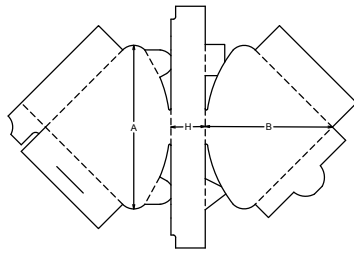

F40.11.00.00

A

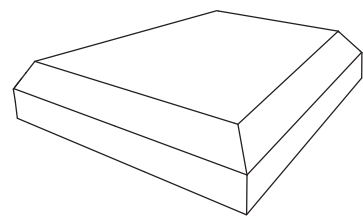
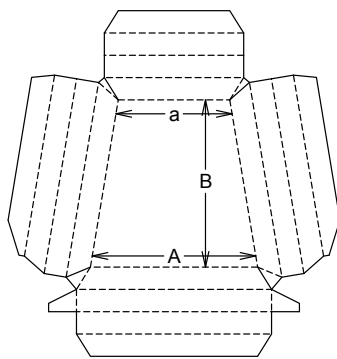

F40.12.00.00

A

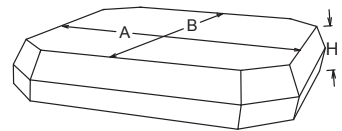
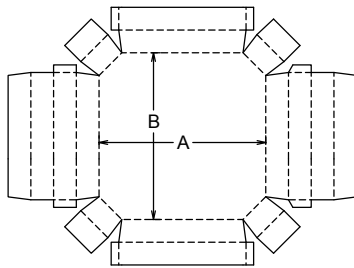

F40.13.00.00

A

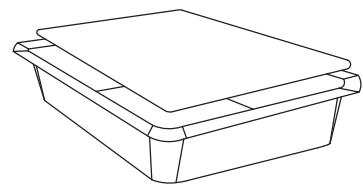
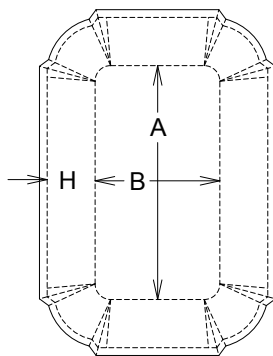

F40.62.00.00

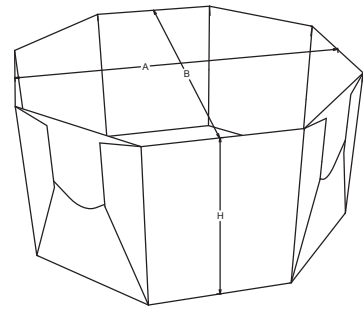
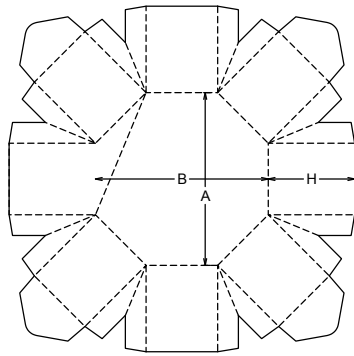

F40.71.00.00

A

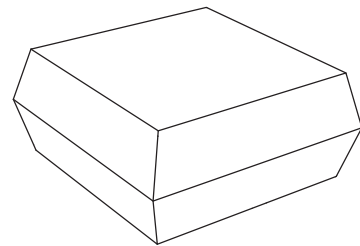
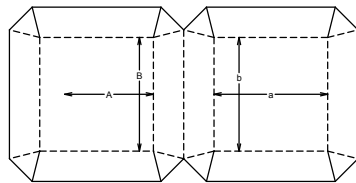

F50.01.00.00

M

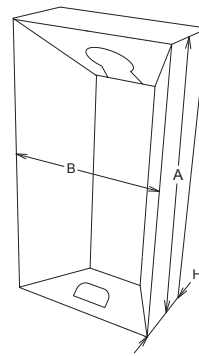
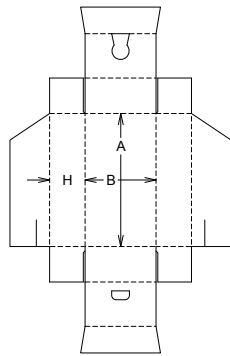

F50.02.00.00

M+A

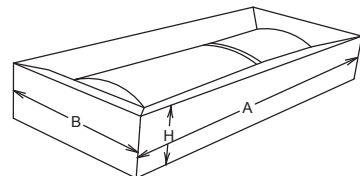
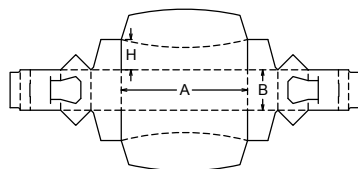

F50.03.00.00

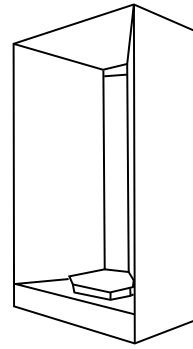
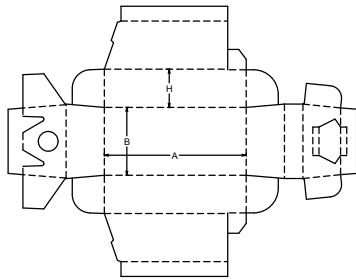

F50.04.00.00

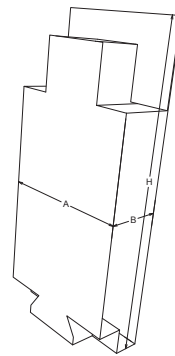
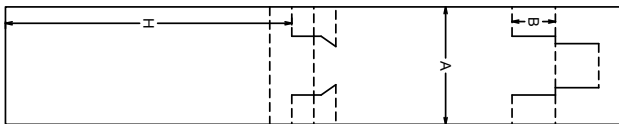

F50.11.00.00

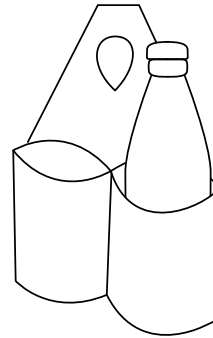
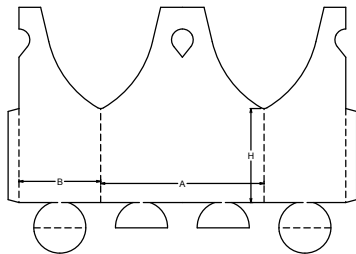

F50.21.00.00

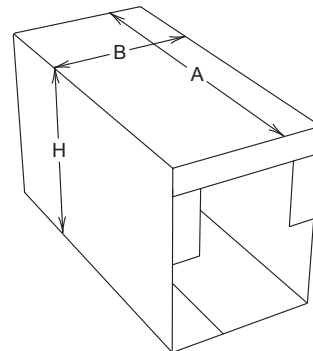
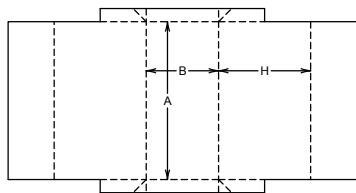

F60.01.00.00

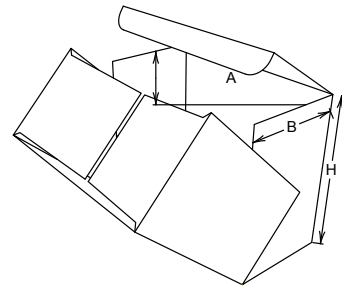
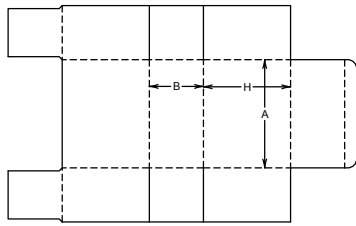

F60.02.00.00

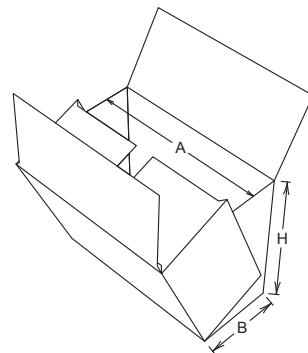
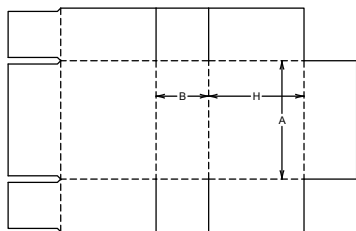

F60.03.00.00

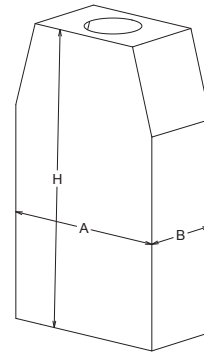
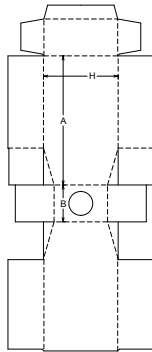

F60.06.00.00

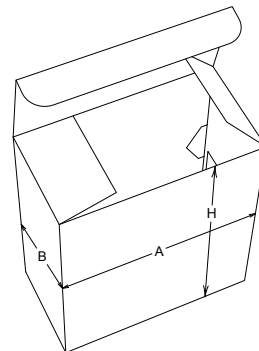
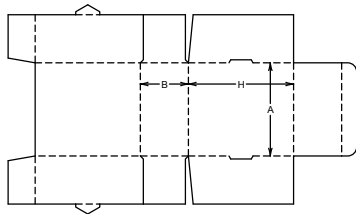

F60.07.00.00

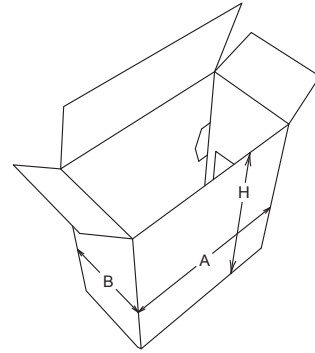
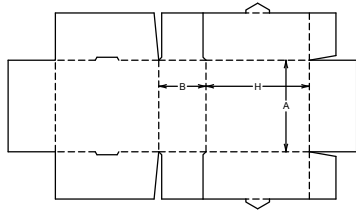

F60.11.00.00

A

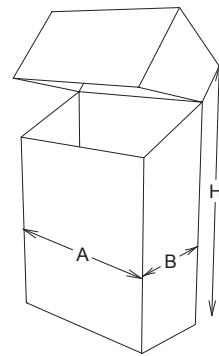
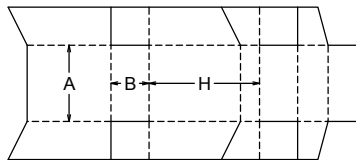

F60.12.00.00

A

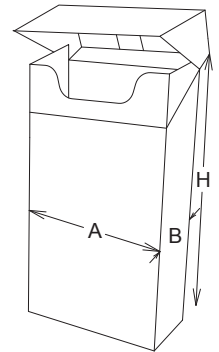
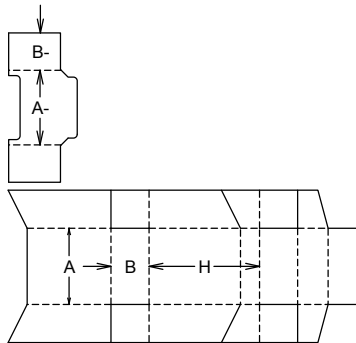

F60.15.00.00

A

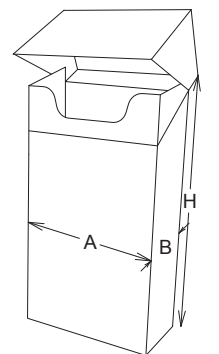
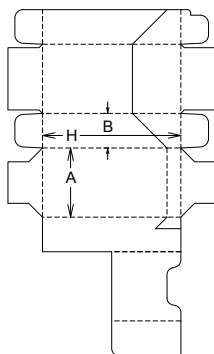

F60.16.00.00

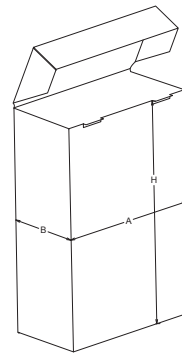
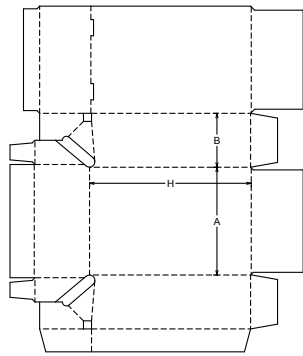

F60.32.00.00

A

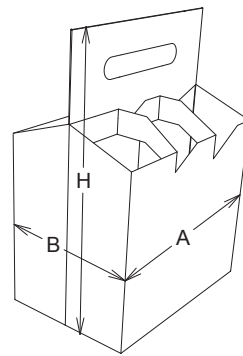
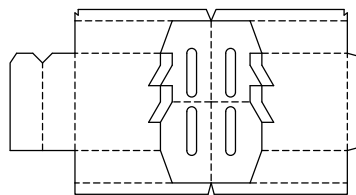

F60.41.00.00

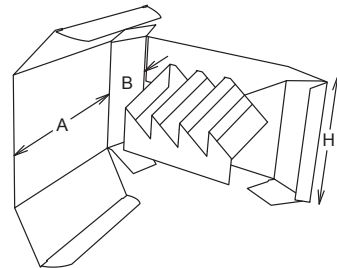
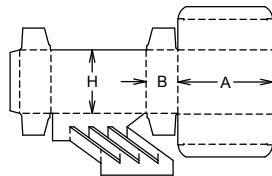

F60.42.00.00

M

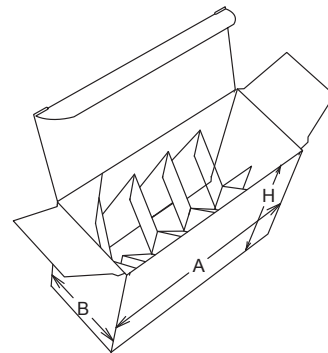
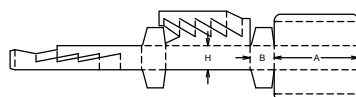

F60.81.00.00

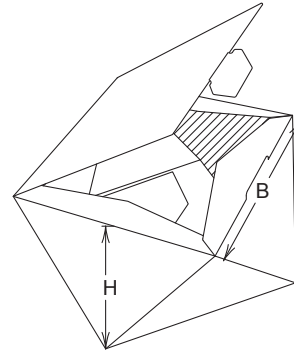
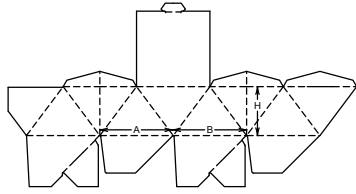

F60.82.00.00

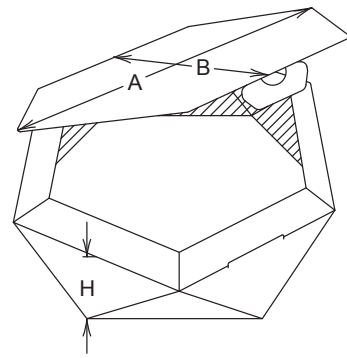
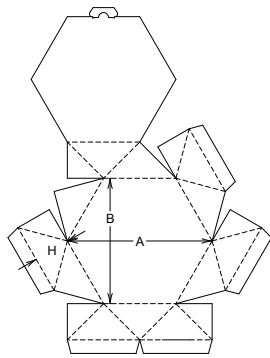

F60.91.00.00

M+A

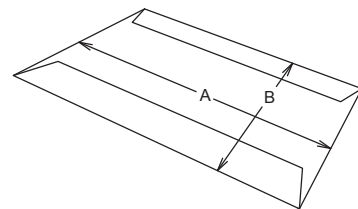
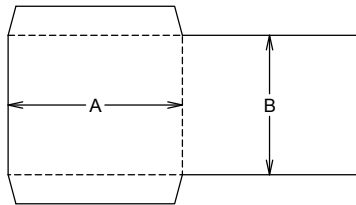

F60.92.00.00

M/A

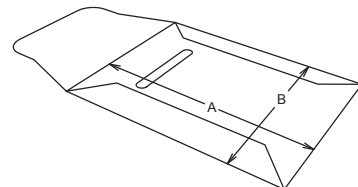
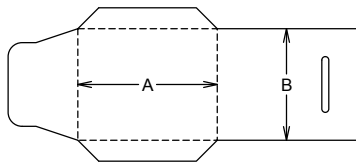

F60.93.00.00

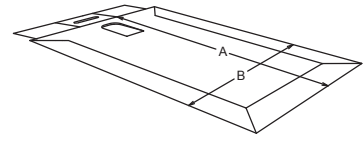
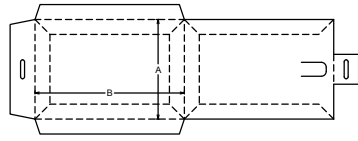

F70.01.00.00

M+A

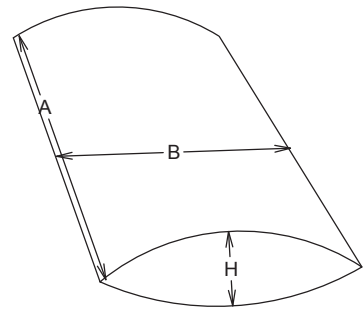
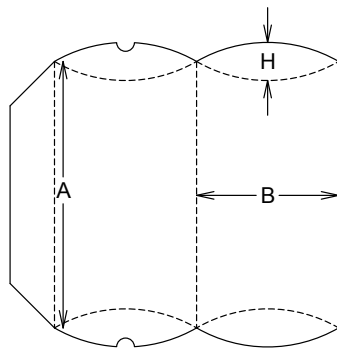

F70.02.00.00

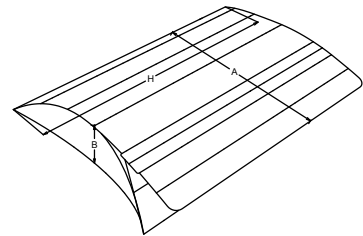
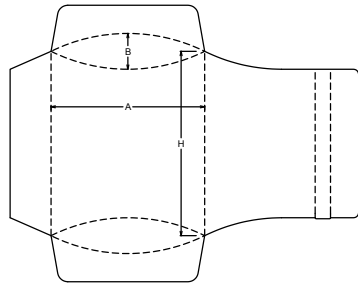

F70.51.00.00

M

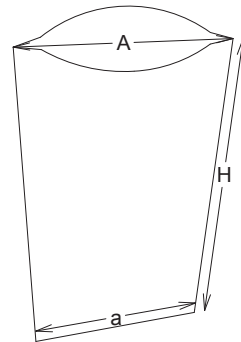
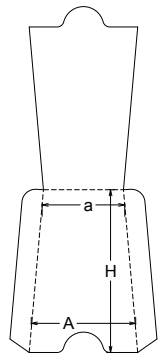

F70.52.00.00

M

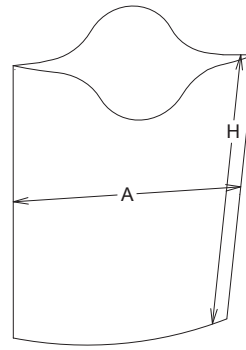
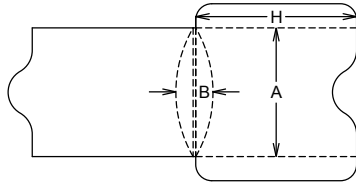

F70.54.00.00

M

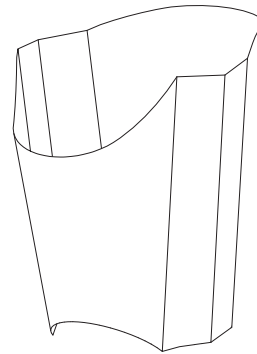
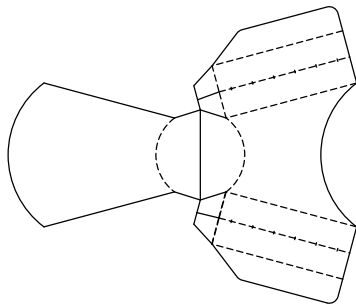

F70.62.00.00

A

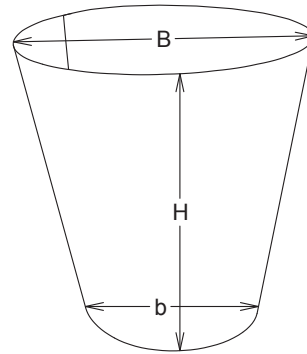
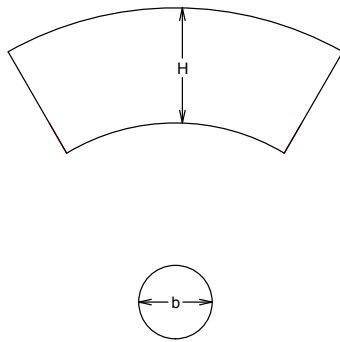

F80.01.00.00

M

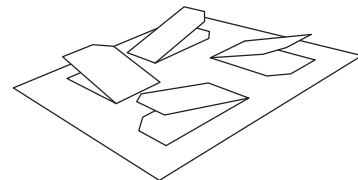
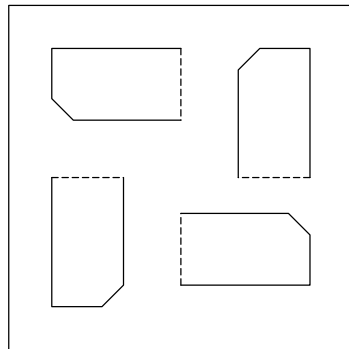

F80.02.00.00

M

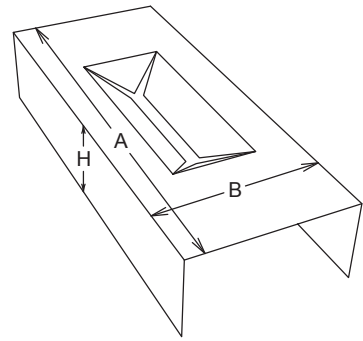
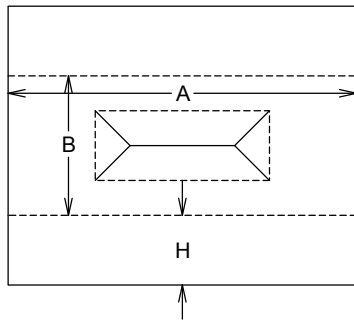

F80.03.00.00

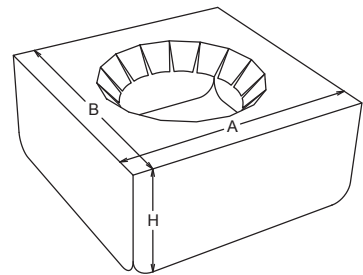
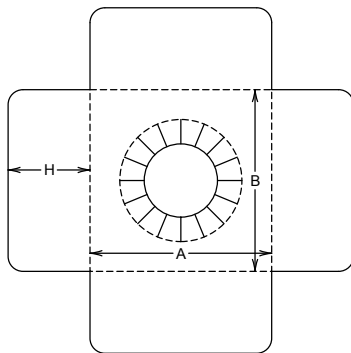

F80.11.00.00

M

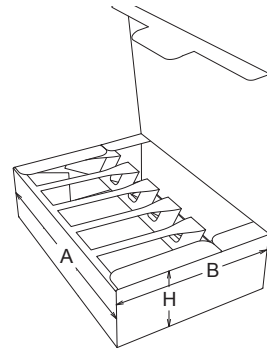
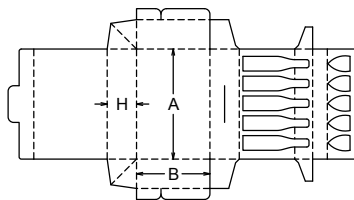

F80.13.00.00

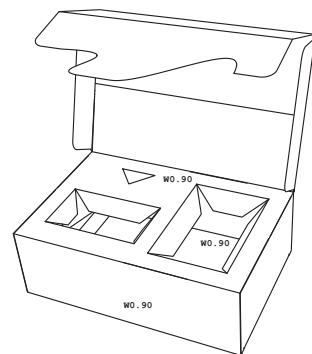
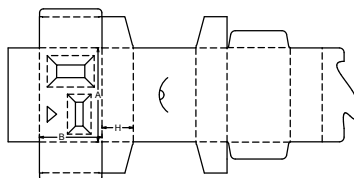

F80.21.00.00

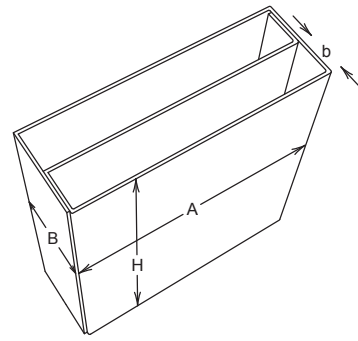
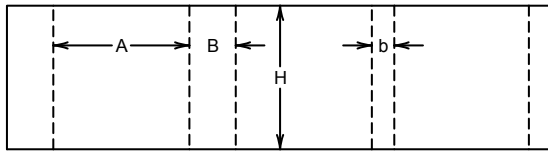

F80.22.00.00

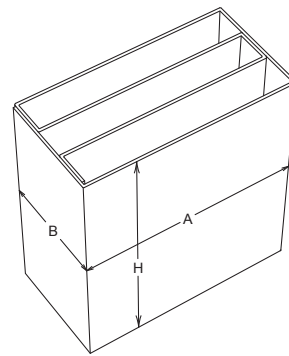
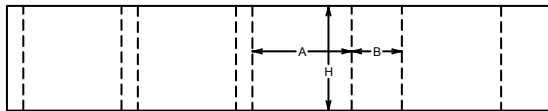

F80.23.00.00

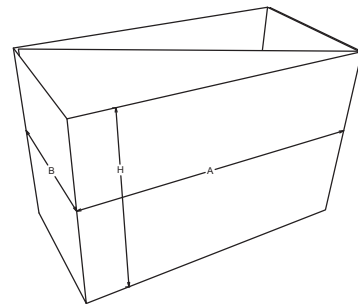
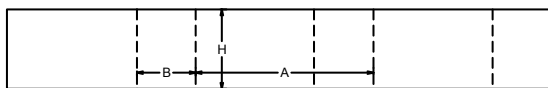

F80.24.00.00

M/A

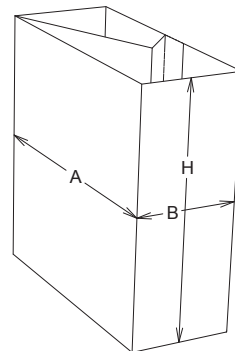
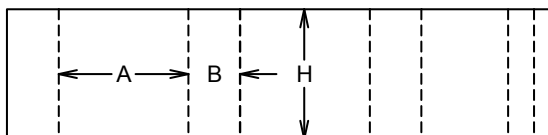

F80.31.00.00

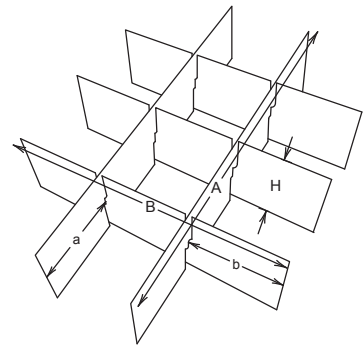
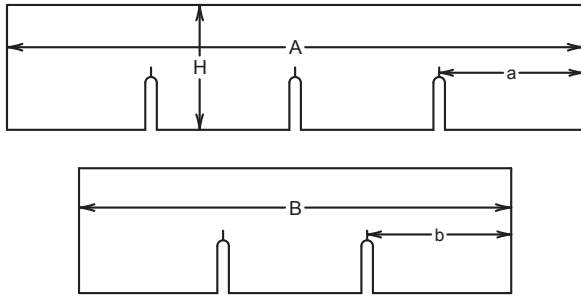

F80.41.00.00

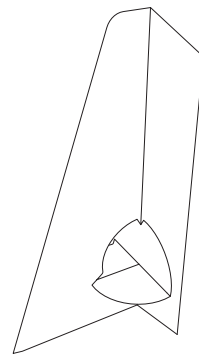
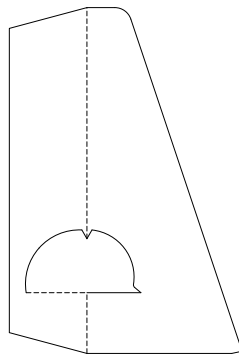

F80.51.00.00

A

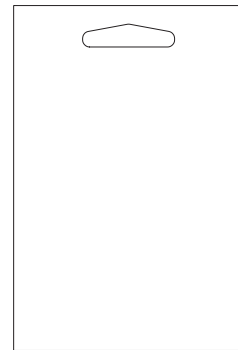

F80.52.00.00

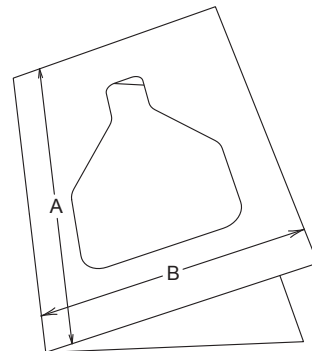
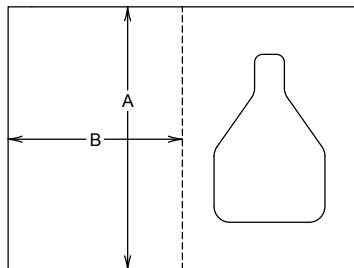

F80.53.00.00

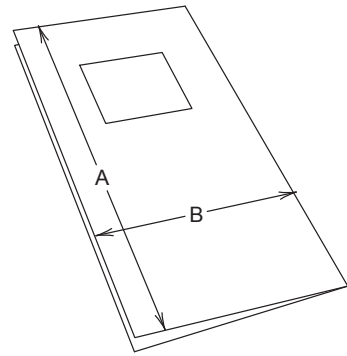
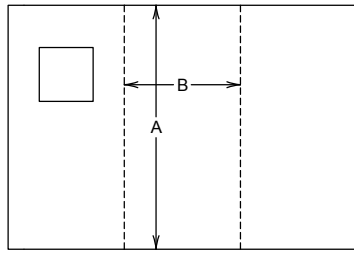

X11

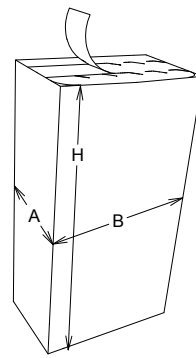
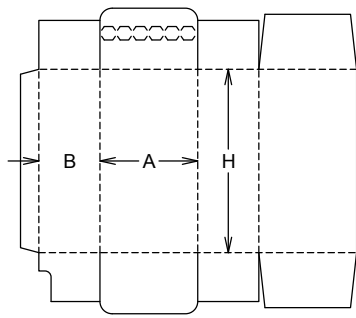

X12

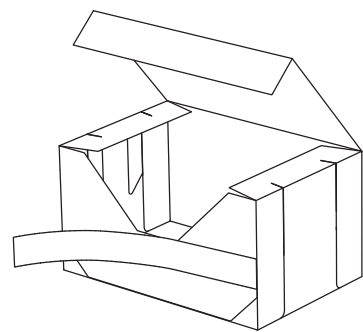
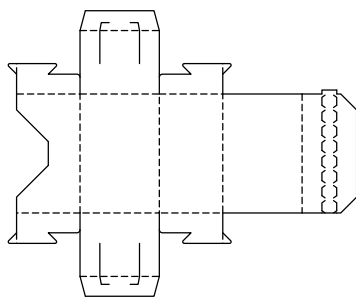

X13

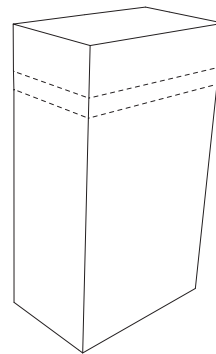
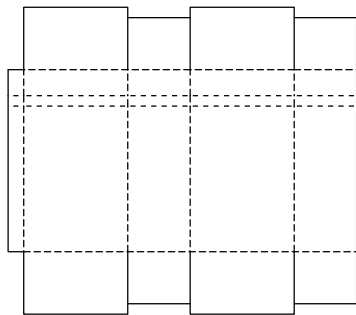

X14

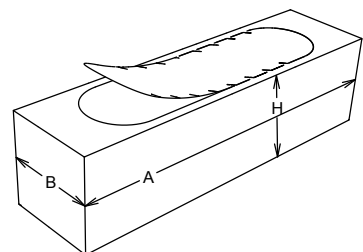
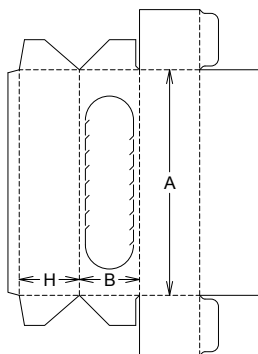

X21

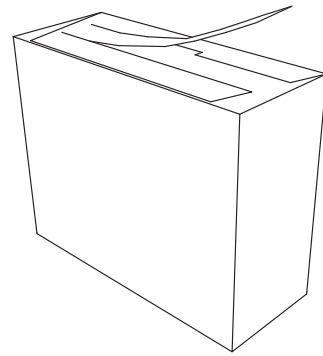
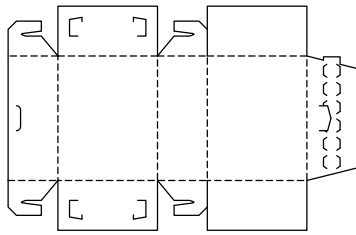

X22

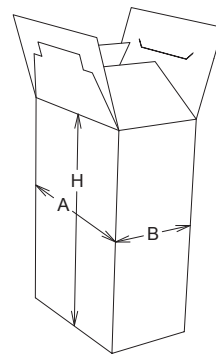
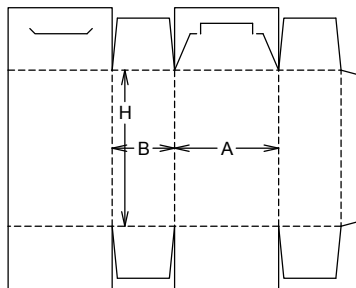

X23

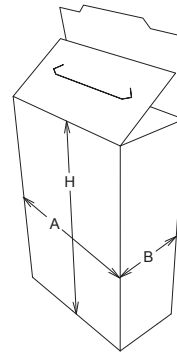
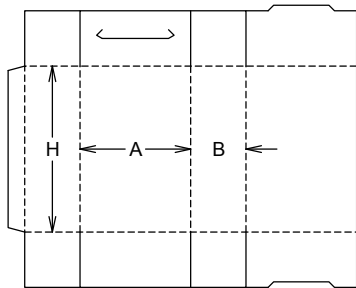

X25

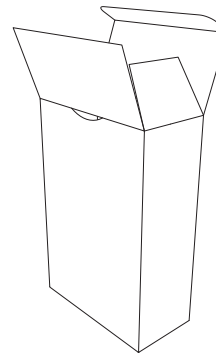
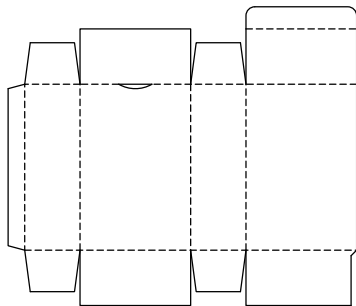

X26

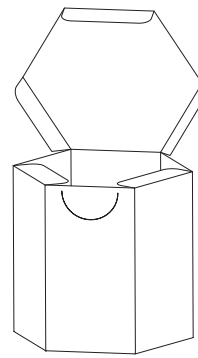
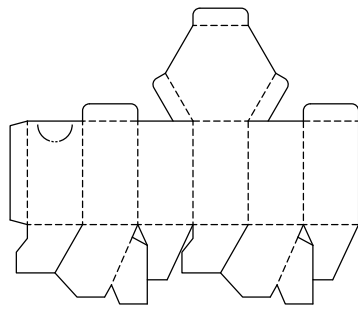

X27

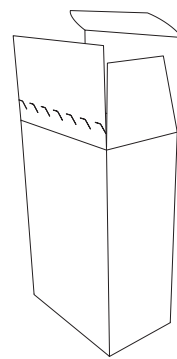
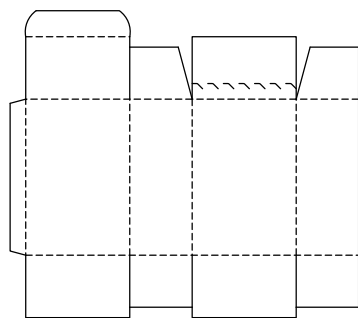

X29

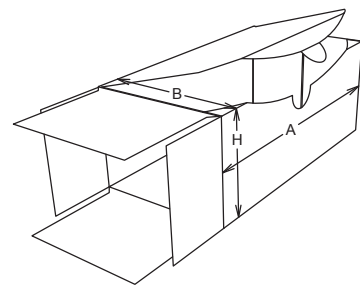
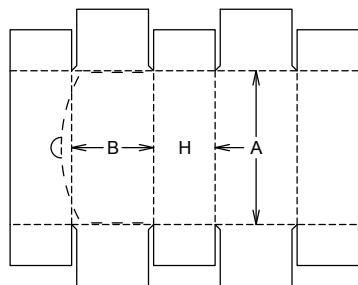

X31

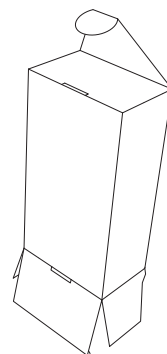
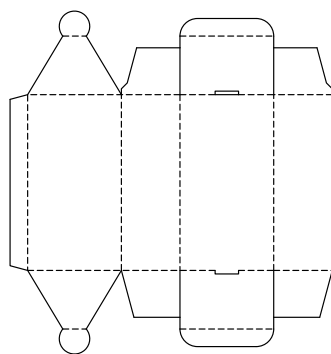

X32

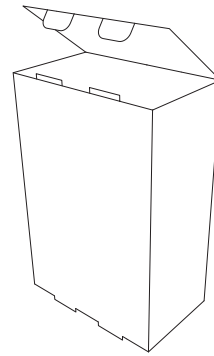
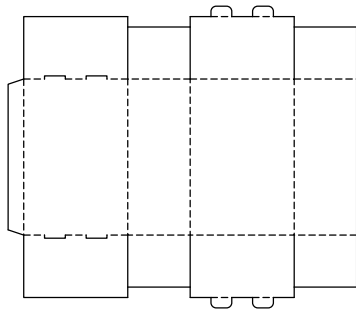

X33

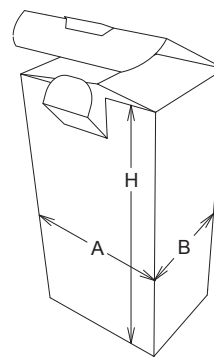
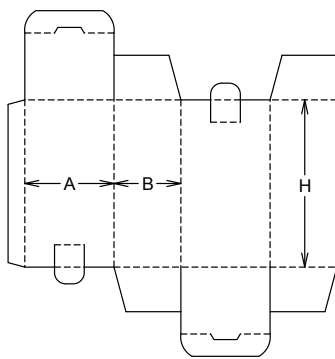

X35

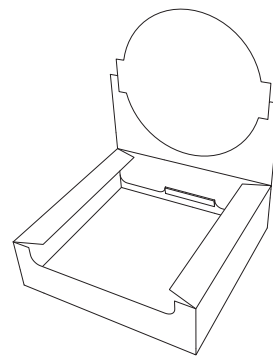
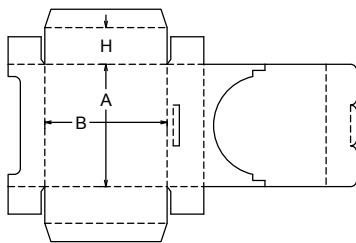

X36

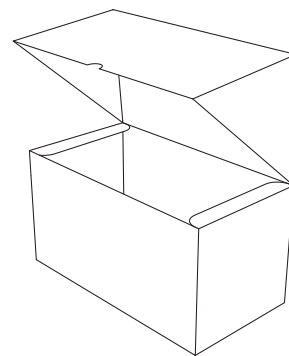
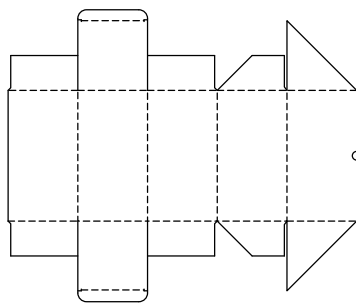

X37

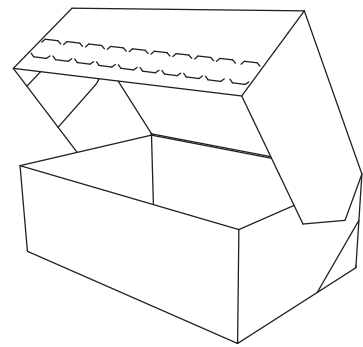
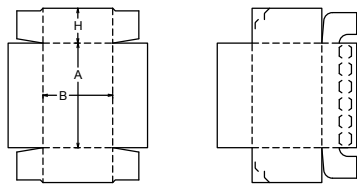

X38

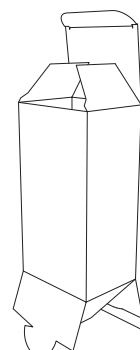
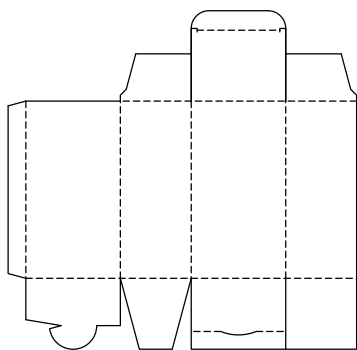

X42

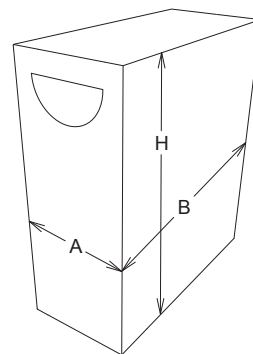
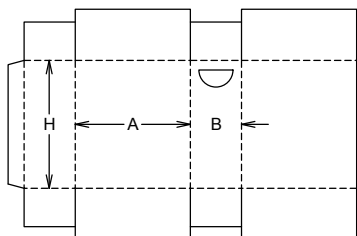

X44

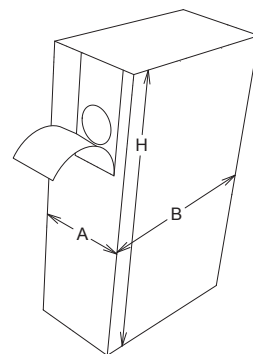
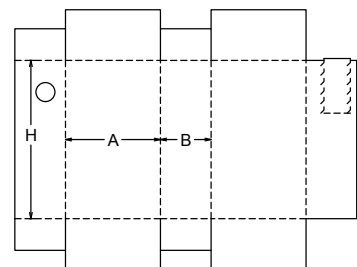

X45

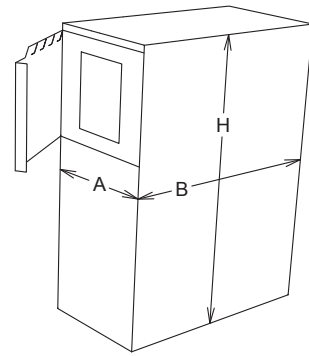
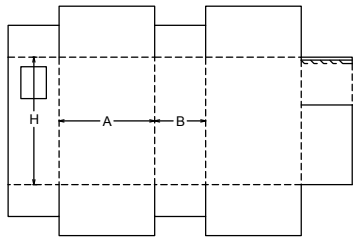

X46

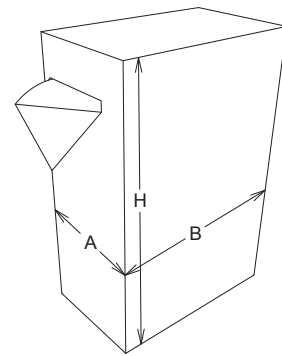
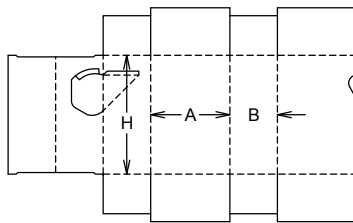

X47

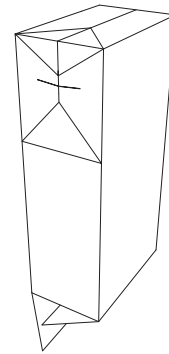
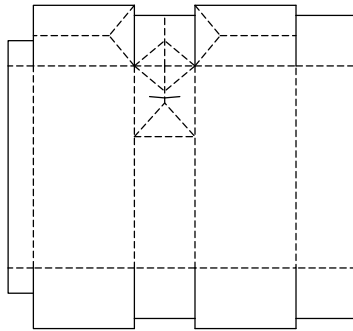

X48

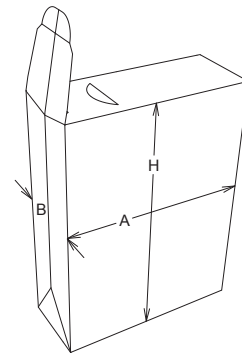
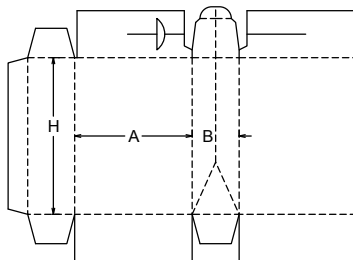

X51

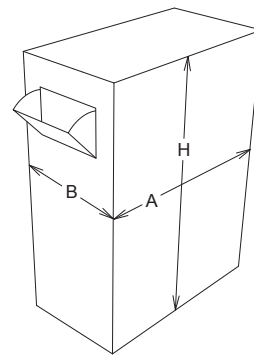
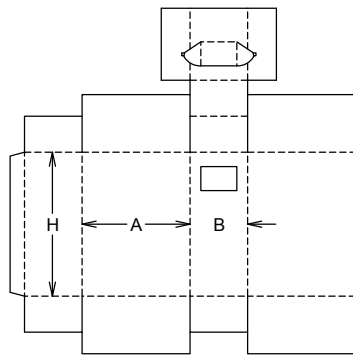

X52

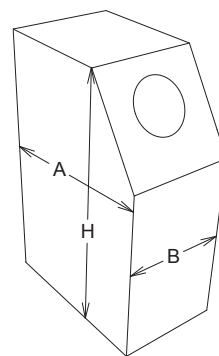
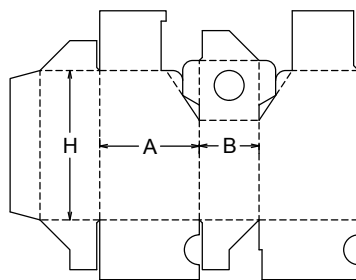

X62

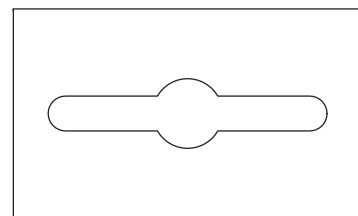
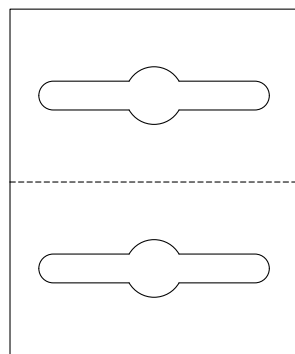

X64

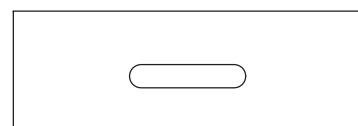
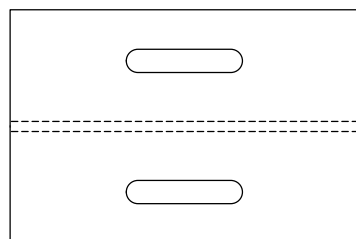

X66

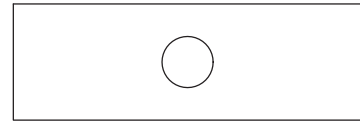
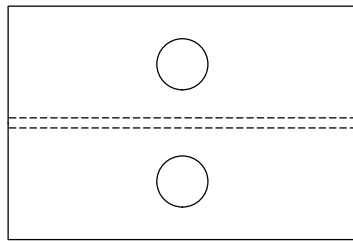

X71

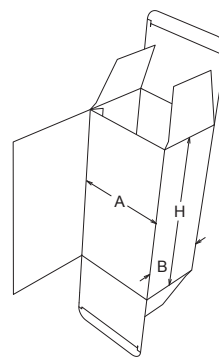
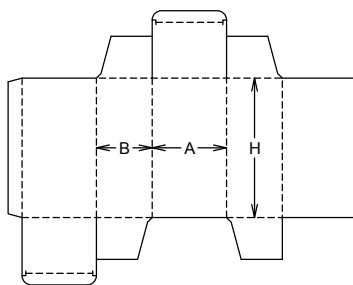

X72

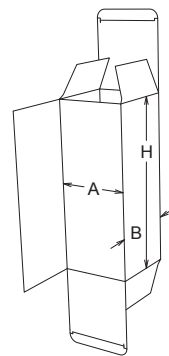
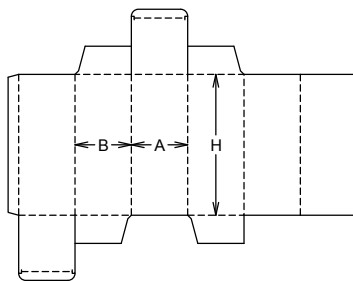

X73

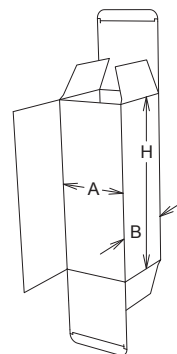
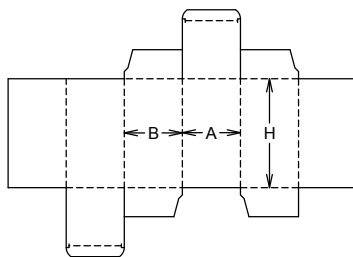

X81

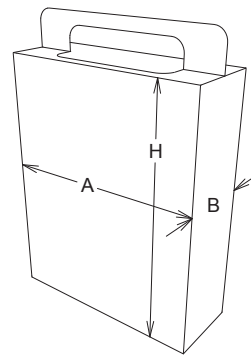
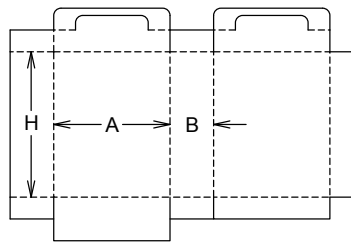

X82

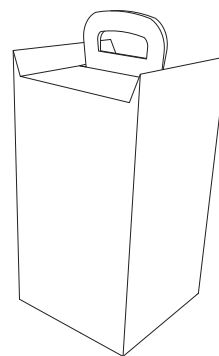
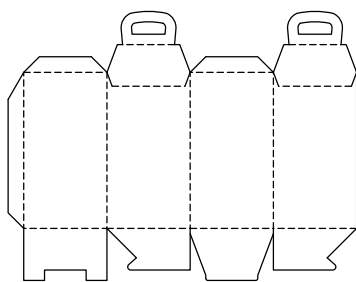

X83

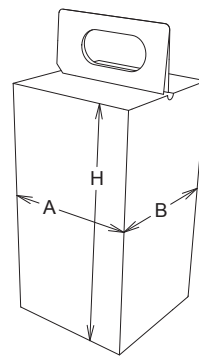
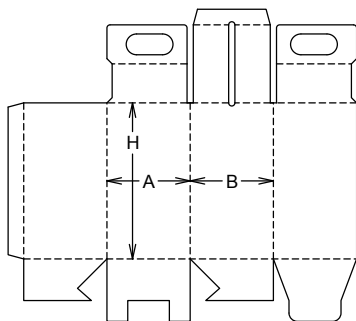

X84

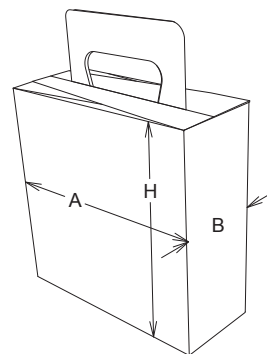
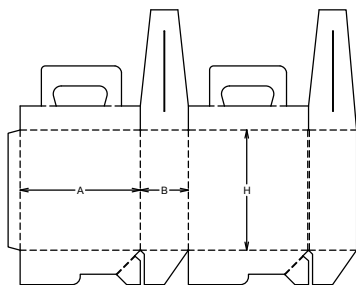

X85

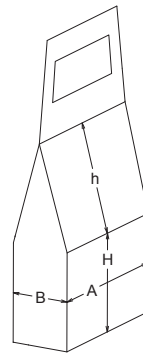
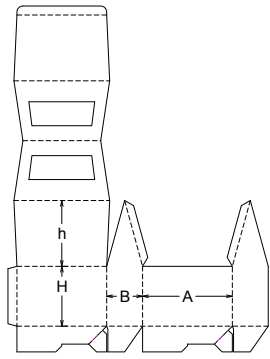

X86

